

Tilting disc check valve

**COBRA<sup>®</sup>-TDC01/TDC03**

## **Installation\Operating manual**

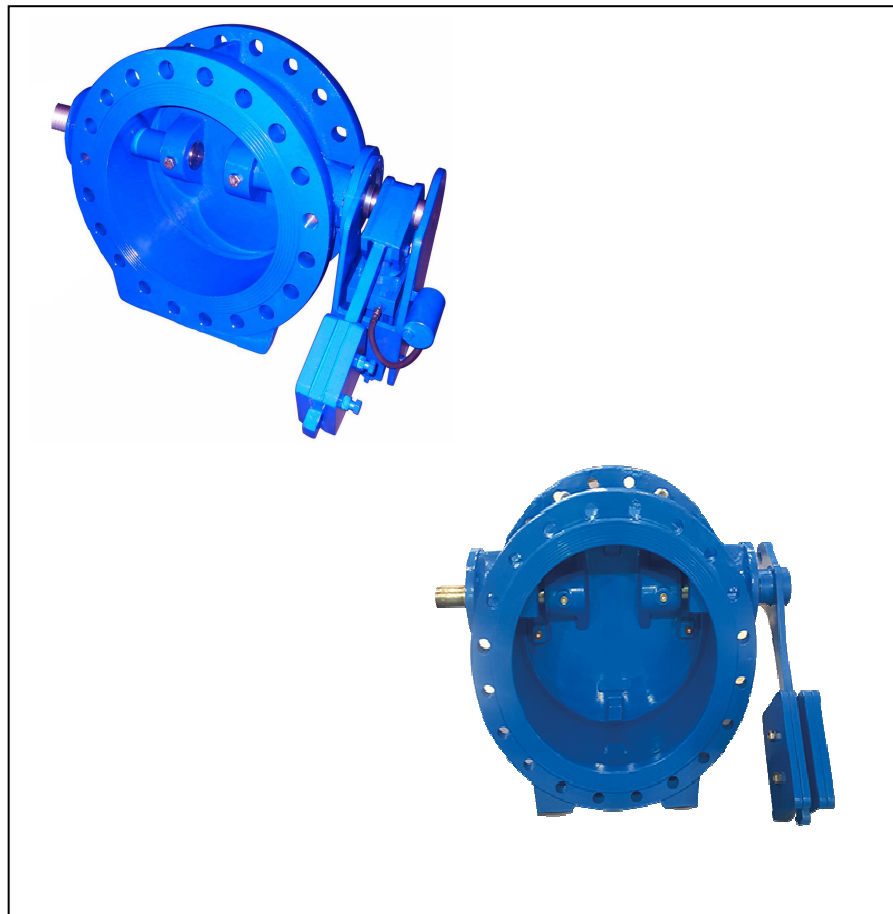

## **Legal information/Copyright**

Installation/Operating Manual COBRA-TDC01/03

Original operating manual

All rights reserved. The contents provided herein must neither be distributed, copied, reproduced, edited or processed for any other purpose, nor otherwise transmitted, published or made available to a third party without the manufacturer's express written consent.  
Subject to technical modification without prior notice.

© KSB SE & Co. KGaA, Frankenthal 07/05/2020

**Contents**

	<b>Glossary .....</b>	<b>5</b>
<b>1</b>	<b>General .....</b>	<b>6</b>
	1.1 Principles.....	6
	1.2 Installation of partly completed machinery.....	6
	1.3 Target group.....	6
	1.4 Other applicable documents.....	6
	1.5 Symbols.....	6
	1.6 Key to safety symbols/markings .....	7
<b>2</b>	<b>Safety.....</b>	<b>8</b>
	2.1 General .....	8
	2.2 Intended use .....	8
	2.2.1 Prevention of foreseeable misuse.....	9
	2.3 Personnel qualification and training.....	9
	2.4 Consequences and risks caused by non-compliance with this manual .....	9
	2.5 Safety awareness .....	9
	2.6 Safety information for the operator/user.....	9
	2.7 Safety information for maintenance, inspection and installation .....	10
	2.8 Unauthorised modes of operation .....	10
<b>3</b>	<b>Transport/Storage/Disposal .....</b>	<b>11</b>
	3.1 Checking the condition upon delivery.....	11
	3.2 Transport.....	11
	3.3 Storage/preservation.....	11
	3.4 Return to supplier .....	12
	3.5 Disposal .....	13
<b>4</b>	<b>Valve Description .....</b>	<b>14</b>
	4.1 General description .....	14
	4.2 Product information .....	14
	4.2.1 EC Machinery Directive 2006/42/EC.....	14
	4.2.2 Product information as per Regulation No. 1907/2006 (REACH) .....	14
	4.3 Marking.....	14
	4.4 Design details.....	14
	4.5 Function .....	15
	4.6 Scope of supply .....	15
	4.7 Noise characteristic .....	15
<b>5</b>	<b>Installation at Site.....</b>	<b>16</b>
	5.1 General information/Safety regulations .....	16
	5.2 Installation position .....	16
	5.3 Preparing the valve .....	17
	5.4 Piping .....	17
	5.4.1 Flange connection.....	18
	5.5 Insulation .....	19
<b>6</b>	<b>Commissioning/Start-up/Shutdown.....</b>	<b>20</b>
	6.1 Commissioning.....	20
	6.1.1 Prerequisites for commissioning/start-up.....	20
	6.1.2 Functional test .....	21
	6.2 Operating limits .....	21
	6.2.1 Pressure/temperature ratings .....	21
	6.2.2 Flow velocity .....	21
	6.3 Shutdown.....	22
	6.3.1 Measures to be taken for shutdown.....	22

6.4	Returning to service .....	22
<b>7</b>	<b>Servicing/Maintenance .....</b>	<b>23</b>
7.1	Safety regulations .....	23
7.2	Servicing/Inspection .....	23
7.2.1	Supervision of operation .....	23
7.2.2	Inspection work .....	24
7.2.3	Dismantling the valve .....	24
7.2.4	Assembling the valve .....	25
7.2.5	Tightening torques .....	26
<b>8</b>	<b>Trouble-shooting .....</b>	<b>27</b>
<b>9</b>	<b>Related Documents .....</b>	<b>28</b>
9.1	List of components .....	28
<b>10</b>	<b>Certificate of Decontamination .....</b>	<b>30</b>
	<b>Index .....</b>	<b>31</b>

## Glossary

### **Certificate of decontamination**

A certificate of decontamination is enclosed by the customer when returning the product to the manufacturer to certify that the product has been properly drained to eliminate any environmental and health hazards arising from components in contact with the fluid handled.

### **PN**

Nominal pressure; a characteristic upon which standards regarding piping, piping components, valves, etc., are based

# 1 General

## 1.1 Principles

This operating manual is valid for the type series and variants indicated on the front cover.

The operating manual describes the proper and safe use of this equipment in all phases of operation.

The name plate indicates the type series, the main operating data and the serial number. The serial number uniquely describes the product and is used as identification in all further business processes.

In the event of damage, immediately contact your nearest KSB sales organisation responsible to maintain the right to claim under warranty.

## 1.2 Installation of partly completed machinery

To install partly completed machinery supplied by KSB refer to the sub-sections under Installation at Site. ( ⇨ Section 5, Page 16)

## 1.3 Target group

This operating manual is aimed at the target group of trained and qualified specialist technical personnel.

## 1.4 Other applicable documents

**Table 1:** Overview of other applicable documents

Document	Contents
Type series booklet	Description of the valve
General assembly drawing <sup>1)</sup>	Sectional drawing of the valve
Sub-supplier product literature	Operating manuals and other product literature describing accessories and integrated machinery components

For accessories and/or integrated machinery components, observe the relevant manufacturer's product literature.

## 1.5 Symbols





**Table 2:** Symbols used in this manual

Symbol	Description
✓	Conditions which need to be fulfilled before proceeding with the step-by-step instructions
▷	Safety instructions
⇨	Result of an action
⇨	Cross-references
1. 2.	Step-by-step instructions
	Note Recommendations and important information on how to handle the product

1) If agreed to be included in the scope of supply

### 1.6 Key to safety symbols/markings

**Table 3:** Definition of safety symbols/markings

Symbol	Description
 <b>DANGER</b>	<b>DANGER</b> This signal word indicates a high-risk hazard which, if not avoided, will result in death or serious injury.
 <b>WARNING</b>	<b>WARNING</b> This signal word indicates a medium-risk hazard which, if not avoided, could result in death or serious injury.
<b>CAUTION</b>	<b>CAUTION</b> This signal word indicates a hazard which, if not avoided, could result in damage to the machine and its functions.
	<b>General hazard</b> In conjunction with one of the signal words this symbol indicates a hazard which will or could result in death or serious injury.
	<b>Electrical hazard</b> In conjunction with one of the signal words this symbol indicates a hazard involving electrical voltage and identifies information about protection against electrical voltage.
	<b>Machine damage</b> In conjunction with the signal word CAUTION this symbol indicates a hazard for the machine and its functions.

## 2 Safety



All the information contained in this section refers to hazardous situations.

In addition to the present general safety information the action-related safety information given in the other sections must be observed.

### 2.1 General

- This operating manual contains general installation, operating and maintenance instructions that must be observed to ensure safe operation of the system and prevent personal injury and damage to property.
- Comply with all the safety instructions given in the individual sections of this operating manual.
- The operating manual must be read and understood by the responsible specialist personnel/operators prior to installation and commissioning.
- The contents of this operating manual must be available to the specialist personnel at the site at all times.
- Information and markings attached directly to the product must always be complied with and kept in a perfectly legible condition at all times. This applies to, for example:
  - Manufacturer
  - Type designation
  - Nominal pressure
  - Nominal size
  
  - Year of construction
  - Valve body material
- The operator is responsible for ensuring compliance with all local regulations not taken into account.
- The design, manufacture and testing of the valve are subject to a QM system to DIN EN ISO 9001 as well as the current European Pressure Equipment Directive.
- Bear in mind that valves exposed to creep-rupture conditions have a limited service life and have to meet the applicable regulations stipulated in the technical codes.
- In the case of customised special variants, further restrictions may apply with regard to the operating mode and service life. Refer to the relevant sales documentation for applicable limitations.
- The operator is responsible for ensuring compliance with all local regulations not taken into account.
- The operator is responsible for any eventualities or incidents which may occur during installation performed by the customer, operation and maintenance.

### 2.2 Intended use

- Only operate valves which are in perfect technical condition.
- Do not operate the valve in partially assembled condition.
- Only use the valve for fluids specified in the product literature. Take the design and material variant into account.
- Only operate the valve within the operating limits described in the other applicable documents.
- The valve's design and rating are based on predominantly static loading in accordance with the codes applied. Consult the manufacturer if the valve is subjected to dynamic loads or any other additional influences.
- Consult the manufacturer about any other modes of operation not described in the product literature.
- Do not use the valve as a foothold.



**2.2.1 Prevention of foreseeable misuse**

- Never exceed the permissible application and operating limits specified in the product literature regarding pressure, temperature, etc.
- Observe all safety information and instructions in this manual.

**2.3 Personnel qualification and training**

- All personnel involved must be fully qualified to transport, install, operate, maintain and inspect the product this manual refers to and be fully aware of the interaction between the valve and the system.
- The responsibilities, competence and supervision of all personnel involved in transport, installation, operation, maintenance and inspection must be clearly defined by the operator.
- Deficits in knowledge must be rectified by means of training and instruction provided by sufficiently trained specialist personnel. If required, the operator can commission the manufacturer/supplier to train the personnel.
- Hands-on training at the valve and the actuator must always be supervised by specialist technical personnel.

**2.4 Consequences and risks caused by non-compliance with this manual**

- Non-compliance with these operating instructions will lead to forfeiture of warranty cover and of any and all rights to claims for damages.
- Non-compliance can, for example, have the following consequences:
  - Hazards to persons due to electrical, thermal, mechanical and chemical effects and explosions
  - Failure of important product functions
  - Failure of prescribed maintenance and servicing practices
  - Hazard to the environment due to leakage of hazardous substances

**2.5 Safety awareness**

In addition to the safety information contained in this operating manual and the intended use, the following safety regulations shall be complied with:

- Accident prevention, health regulations and safety regulations
- Explosion protection regulations
- Safety regulations for handling hazardous substances
- Applicable standards, directives and laws

**2.6 Safety information for the operator/user**

Actuator-operated valves are intended for use in areas which cannot be accessed by unauthorised persons. Operation of these valves in areas which can be accessed by unauthorised persons is only permitted if appropriate protective devices are fitted at the site. This must be ensured by the operator.

- Fit protective equipment (e.g. contact guards) supplied by the operator for hot, cold or moving parts, and check that the equipment functions properly. Do not touch rotating parts.
- Do not remove any protective equipment (e.g. contact guards) during operation.
- Provide the personnel with protective equipment and make sure it is used.
- Contain any leakage of hazardous fluids (e.g. explosive, toxic, hot) so as to avoid any danger to persons and the environment. Adhere to all relevant laws.
- Eliminate all electrical hazards. (In this respect refer to the applicable national safety regulations and/or regulations issued by the local energy supply companies.)

### **2.7 Safety information for maintenance, inspection and installation**

- Modifications or alterations of the valve require the manufacturer's prior consent.
- Use only original spare parts or parts/components authorised by the manufacturer. The use of other parts/components can invalidate any liability of the manufacturer for resulting damage.
- The operator ensures that maintenance, inspection and installation are performed by authorised, qualified specialist personnel who are thoroughly familiar with the manual.
- Carry out work on the valve during standstill only.
- The valve body must have cooled down to ambient temperature.
- The pressure in the valve body must have been released and the valve must have been drained.
- When taking the valve out of service always adhere to the procedure described in the manual.
- Decontaminate valves which handle fluids posing a health hazard.
- Protect the valve body from any impacts.
- As soon as the work has been completed, re-install and re-activate any safety-relevant devices and protective devices. Before returning the product to service, observe all instructions on commissioning.

### **2.8 Unauthorised modes of operation**

- The valve is operated outside the limits stated in the operating manual.
- The valve is not operated in accordance with the intended use.

(⇒ Section 2.2, Page 8)

### 3 Transport/Storage/Disposal

#### 3.1 Checking the condition upon delivery

1. On transfer of goods, check each packaging unit for damage.
2. In the event of in-transit damage, assess the exact damage, document it and notify KSB or the supplying dealer and the insurer about the damage in writing immediately.

#### 3.2 Transport

	<b>DANGER</b>
	<p><b>The valve could slip out of the suspension arrangement</b>            Danger to life from falling parts!</p> <ul style="list-style-type: none"> <li>• Only transport the valve in the specified position.</li> <li>• Never attach lifting accessories to the lever or valve disc.</li> <li>• Observe the information on weights, centre of gravity and fastening points.</li> <li>• Observe the applicable local accident prevention regulations.</li> <li>• Use suitable, permitted lifting accessories, e.g. self-tightening lifting tongs.</li> </ul> <p style="text-align: center;">Transport aids on the actuator are not suitable for suspending the entire valve/actuator assembly.</p>

To transport the valve, suspend it as illustrated.

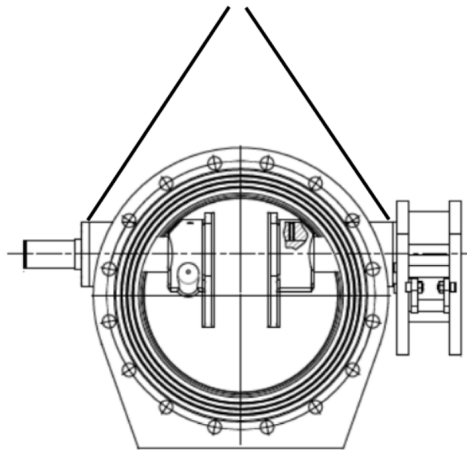



**Fig. 1:** Transporting the valve

Suspend the valve with the lifting equipment and transport it.

#### 3.3 Storage/preservation

If commissioning is to take place some time after delivery, we recommend that the following measures be taken for storing the valve:

	<p style="background-color: yellow; margin: 0;"><b>CAUTION</b></p> <p><b>Damage due to frost, humidity or dirt</b> Corrosion/contamination of the valve!</p> <ul style="list-style-type: none"> <li>▷ Store the valve in a dry, dust-free and vibration-free, frost-proof room where the atmospheric humidity is as constant as possible.</li> <li>▷ Protect the valve against contamination, e.g. with suitable caps or film.</li> </ul>
	<p style="background-color: yellow; margin: 0;"><b>CAUTION</b></p> <p><b>Damage due to excessive valve closure</b> Damage to the seat/disc interface!</p> <ul style="list-style-type: none"> <li>▷ Store the valve with the valve disc at 5° from the closed position.</li> </ul>

Storage and/or temporary storage of the valves must ensure that even after a prolonged period of storage the valves' function is not impaired.

The temperature at the storage location must be between +5 °C and +50 °C.

Protect the sealing elements (elastomers) from sunlight or UV light from other sources. Observe the DIN 7716 standard for the storage of elastomers.

Cover the dumper to protect them from dust and dirt, and protect them from mechanical damage.

If properly stored indoors, the equipment is protected for a maximum of 12 months. New valves are supplied by our factory duly prepared for storage.



For storing a valve which has already been operated, observe the measures to be taken for shutdown. (⇨ Section 6.3, Page 22)

### 3.4 Return to supplier

1. Drain the valve as described in the manual.
2. Flush and clean the valve, particularly if it has been used for handling noxious, explosive, hot or other hazardous fluids.
3. If the valve has handled fluids whose residues could lead to corrosion damage in the presence of atmospheric humidity or could ignite upon contact with oxygen also neutralise the valve and blow through with anhydrous inert gas to ensure drying.
4. When returning valves used for handling Fluids in Group 1 always complete and enclose a certificate of decontamination.  
Indicate any safety measures and decontamination measures taken.

	<p style="background-color: blue; color: white; margin: 0;"><b>NOTE</b></p> <p>If required, a blank certificate of decontamination can be downloaded from the following web site: <a href="http://www.ksb.com/certificate_of_decontamination">www.ksb.com/certificate_of_decontamination</a></p>
---	--

## 3.5 Disposal

	 <b>WARNING</b>
	<p><b>Fluids handled, consumables and supplies which are hot or pose a health hazard</b> Hazard to persons and the environment!</p> <ul style="list-style-type: none"><li>· Collect and properly dispose of flushing fluid and any residues of the fluid handled.</li><li>· Wear safety clothing and a protective mask if required.</li><li>· Observe all legal regulations on the disposal of fluids posing a health hazard.</li></ul>

1. Dismantle the valve. Collect greases and other lubricants during dismantling.
2. Separate and sort the valve materials, e.g. by:
  - Metals
  - Plastics
  - Electronic waste
  - Greases and other lubricants
3. Dispose of materials in accordance with local regulations or in another controlled manner.

## 4 Valve Description

### 4.1 General description

- Tilting disc check valve, epoxy-coated

Check valve for irrigation systems, cooling circuits, water treatment and water supply systems.

### 4.2 Product information

#### 4.2.1 EC Machinery Directive 2006/42/EC

The valve meets the fundamental safety requirements as per EC Machinery Directive 2006/42/EC, Annex 1.

#### 4.2.2 Product information as per Regulation No. 1907/2006 (REACH)

For information as per chemicals Regulation (EC) No. 1907/2006 (REACH), see <http://www.ksb.com/reach>.

### 4.3 Marking

Nominal size	DN ...
Nominal pressure class	PN ...
Manufacturer	KSB
Type series/Model	COBRA-TDC
Material	.....
Flow direction arrow	→

### 4.4 Design details

#### Design

- Double-flanged body with short face-to-face length to EN 558/14
- Flanged ends to DIN EN 1092-2:
  - PN 10 ≤ DN 1400
  - PN 16 ≤ DN 1400
  - PN 25 ≤ DN 1000
  - PN 40 ≤ DN 1000
- Design to EN 16767
- Tested to EN 12266-1
- Marked in accordance with DIN EN 19 (ISO 5209)
- Perfectly tight shut-off (no leakage visible to the naked eye)
- Valve certified for drinking water applications to WRAS (elastomer and coating)

#### 4.5 Function

- Design** The Tilting check valve consists of the pressure-retaining parts, i.e. the body, the actuating shaft, the functional unit (shaft, valve disc), and the elastomer ring on disc.
- Function** The valve is opened via pressure in the pipeline and closed by the backpressure with the counterweight.
- Sealing** The valve disc and actuating shaft are joined by keys and sealed to atmosphere by the O-rings.

#### 4.6 Scope of supply

The following items are included in the scope of supply:

- Valve
- Valve operating manual

#### 4.7 Noise characteristic

When operated within the operating conditions documented in the order confirmation and/or characteristic curves booklets, the valve will not exceed a sound pressure level of 80 dB in acc. with IEC 60534-8-4. Unfavourable piping layouts or off-design operating conditions may give rise to physical phenomena like cavitation, resulting in significantly higher sound pressure levels.

## 5 Installation at Site

### 5.1 General information/Safety regulations

The consultant, construction company or operator are responsible for positioning and installing the valves. Planning errors and installation errors may impair the reliable function of the valves and pose a substantial safety hazard.

	<b>WARNING</b>
	<p><b>Damage to pressure enclosure or add-on parts</b>                  Leakage from or rupture of the valve                  Valve/add-on parts not functional</p> <ul style="list-style-type: none"> <li>• Check the valve for in-transit damage prior to installation.</li> <li>• Check any add-on parts for in-transit damage.</li> <li>• Do not install damaged valves.</li> </ul>

### 5.2 Installation position

	<b>CAUTION</b>
	<p><b>Valves installation</b>                  No valve function!</p> <ul style="list-style-type: none"> <li>• Valves can be installed in vertical or horizontal position (position of counterweight is different)</li> <li>• If installation is vertical, the flow should come from the ground.</li> </ul>

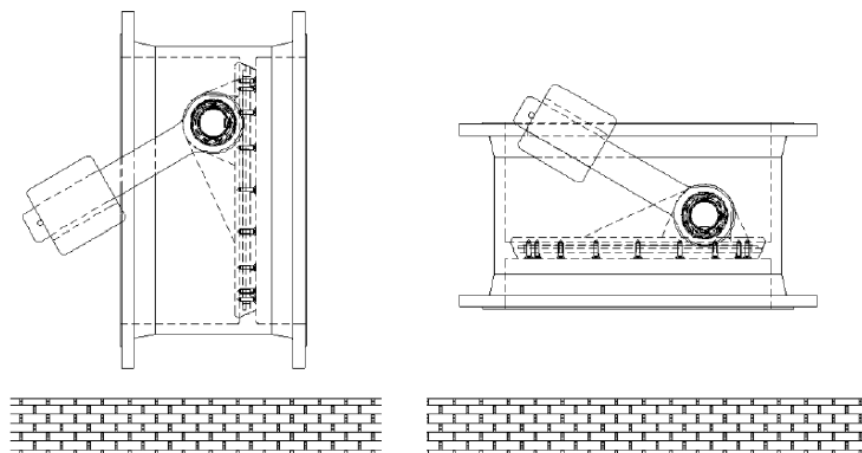
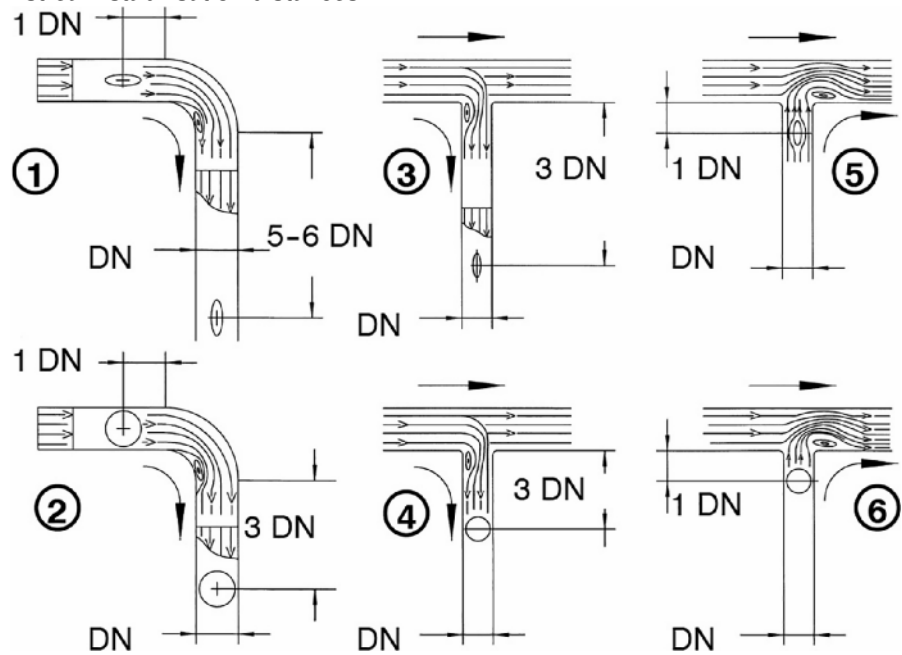

Fig. 2: Horizontal and vertical installation positions

	<b>DANGER</b>
	<p><b>Dead-end valve</b>                  High-pressure hazard!                  Risk of burns!</p> <ul style="list-style-type: none"> <li>• Block the valve against unauthorised and/or unintentional opening.</li> </ul>



Recommended upstream and downstream stabilisation distances



**Fig. 3:** Recommended minimum distance between the valve and a tee or elbow  
Upstream and downstream stabilisation distances are also required for valves installed on the pump discharge side.

**Installation downstream of control valves, a plunger valve or a flow meter**

Observe a minimum distance of 10 times the nominal size.

**5.3 Preparing the valve**

	<b>CAUTION</b>
	<p><b>Outdoor installation</b> Damage due to corrosion! Provide weather-proof protection to protect the valve against moisture.</p>

1. Thoroughly clean, flush and blow through all vessels, piping and connections.
2. Remove the valve's flange covers before installing it in the piping.
3. Check that the inside of the valve is free from any foreign objects. Remove any foreign objects.
4. If required, install a strainer in the piping.

**5.4 Piping**

	<b>WARNING</b>
	<p><b>Impermissible piping forces</b> Leakage from or rupture of the valve body! Connect the pipes to the valve without transmitting any stresses or strains. Take structural measures to prevent any piping forces from being transmitted to the valve. Avoid mechanical loads beyond normal levels, e.g. piping forces, moments and vibrations.</p>

	<b>CAUTION</b>
	<p><b>Painting pipes and actuator</b>          Valve function impaired!</p> <p>▷ Protect stem, plastic components prior to applying paint.</p>

- For any further work (e.g. construction work, cleaning measures) protect the valve and the piping against contamination (e.g. by covering it with a tarpaulin).

**5.4.1 Flange connection**

**Fasteners** Always use all flange bolt holes provided when connecting the valve to the piping.  
**Flange connection** ✓ The mating flange faces are clean and undamaged.

- ✓ Verify that the piping is correctly aligned and the flanges are parallel.
- ✓ The inside diameter of the pipe flanges is within the permissible minimum and maximum diameter limits.
- ✓ Open and close the valve to check that the valve disc rotates freely.
  1. Move the valve to the open position. Open it as far as possible without the valve disc protruding beyond the body.
  2. Pushy the pipe flanges as far apart as required to achieve a sufficient clearance between the flange faces and the protruding liner faces.
  3. Insert the valve between the two flanges and centre it with tie bolts.
  4. Tighten the fasteners evenly and crosswise with a suitable tool until contact is established between the body and the piping flanges.
- 5. Operate the valve several times to verify that the valve disc rotates freely.

### 5.5 Insulation

	<b>WARNING</b>
	<b>Cold/hot piping and/or valve</b> Risk of thermal injury! <ul style="list-style-type: none"><li>· Insulate the valve.</li><li>· Fit warning signs.</li></ul>



For any insulation fitted on the valve observe the following:

- The valve's function must not be impaired.

## 6 Commissioning/Start-up/Shutdown

### 6.1 Commissioning

	<b>CAUTION</b>
	<p><b>Welding beads, scale and other impurities in the piping</b> Damage to the valve!</p> <ul style="list-style-type: none"> <li>· Remove any impurities from the piping, e.g. by flushing the pipe with the valve in fully open position.</li> <li>· If necessary, install a strainer.</li> </ul>

	 <b>DANGER</b>
	<p><b>Risk of pressure surges / water hammer</b> Danger to life caused by burns or scalds!</p> <ul style="list-style-type: none"> <li>· Do not exceed the valve's maximum permissible pressure.</li> <li>· The operator shall provide general safety measures for the system.</li> </ul>

#### 6.1.1 Prerequisites for commissioning/start-up

Before commissioning/start-up of the valve ensure that the following requirements are met:

- The valve has been connected to the piping at both ends.
- The shut-off function of the installed valve has been checked by opening and closing it several times.
- The piping has been flushed.
- The material, pressure data and temperature data of the valve are compatible with the operating conditions of the piping. (⇒ Section 6.2, Page 21)
- The material's chemical resistance and stability under load have been checked.

**6.1.2 Functional test**

The following functions must be checked:

1. Check the shut-off function of the installed valve prior to commissioning/startup by opening and closing the valve several times.

**6.2 Operating limits**
**6.2.1 Pressure/temperature ratings**

**Table 4:** Permissible operating pressures [bar]

PN	DN	[°C]
		80
10	100-1400	10,0
16	100-1400	16,0
25	100-1000	25,0
40	100-1000	40,0

**6.2.2 Flow velocity**

**Table 5:** Permissible flow velocity with the valve fully open

PN	[m/s]
10	3,0
16	4,0
25	5,0
40	6,0

## 6.3 Shutdown

### 6.3.1 Measures to be taken for shutdown

During prolonged shutdown periods, ensure that the following conditions are met:

1. Drain fluids which change their physical condition due to changes in concentration, polymerisation, crystallisation, solidification, etc. from the piping.
2. If required, flush the piping with the valves fully opened.



## 6.4 Returning to service

For returning the equipment to service, observe the sections on commissioning/startup and the operating limits (⇔ Section 6.2, Page 21) .



In addition, carry out all servicing/maintenance operations before returning the valve to service. (⇔ Section 7, Page 23)

## 7 Servicing/Maintenance

### 7.1 Safety regulations

	 <b>DANGER</b>
	<p><b>Valve under pressure</b></p> <p>Risk of injury! Leakage of hot and/or toxic fluids! Risk of burns!</p> <ul style="list-style-type: none"> <li>· Depressurise the valve and its surrounding system prior to any maintenance work and installation work.</li> <li>· If there is fluid leakage, depressurise the valve.</li> <li>· Allow the valve to cool down until the temperature of the fluid in all the valve's chambers is lower than the fluid's vaporisation temperature.</li> </ul>

The operator ensures that maintenance, inspection and installation are performed by authorised, qualified specialist personnel who are thoroughly familiar with the manual.

	 <b>WARNING</b>
	<p><b>Fluids handled, consumables and supplies which are hot and/or pose a health hazard</b></p> <p>Risk of injury!</p> <ul style="list-style-type: none"> <li>· Observe all relevant laws.</li> <li>· When draining the fluid take appropriate measures to protect persons and the environment.</li> <li>· Decontaminate valves used in fluids posing a health hazard.</li> </ul>

	<b>NOTE</b>
	<p>Before removing the valve from the piping, ensure that the pipe has been taken out of service and released for repair/maintenance work.</p>

	<b>NOTE</b>
	<p>All maintenance work, service work and installation work can be carried out by KSB Service or authorised workshops. For contact details please refer to the enclosed "Addresses" booklet or visit "<a href="http://www.ksb.com/contact">www.ksb.com/contact</a>" on the Internet.</p>

Never use force when dismantling and reassembling the valve.

Original spare parts are only ready for operation following assembly/installation and subsequent shell and leak testing of the valve.

### 7.2 Servicing/Inspection

#### 7.2.1 Supervision of operation

The service life can be extended by taking the following measures:

- Checking the function by actuating the valve at least twice a year
- Replacing the valve disc sealing element in good time. Replace the O-ring and the gasket.

7.2.2 Inspection work



7.2.2.1 Lubrication

	<b>NOTE</b>
	Use only lubricants that are suitable for drinking water applications. Observe the national and/or local applicable regulations.

1. Clean any dirty components.
2. Re-lubricate the valve disc sealing element, O-ring and gasket whenever they have been replaced.

7.2.3 Dismantling the valve

7.2.3.1 General information/Safety regulations

	<b>⚠ WARNING</b>
	<p><b>Hot surface</b> Risk of injury!</p> <ul style="list-style-type: none"> <li>• Allow the valve to cool down to ambient temperature.</li> </ul>
	<b>⚠ WARNING</b>
	<p><b>Unqualified personnel performing work on the valve</b> Risk of injury!</p> <ul style="list-style-type: none"> <li>• Always have repair work and maintenance work performed by specially trained, qualified personnel.</li> </ul>

Always observe the safety instructions and information. (⇔ Section 7, Page 23)  
In the event of damage you can always contact KSB Service.

7.2.3.2 Dismantling the piping

- ✓ The notes and steps stated in ( ⇔ Section 7.2.3.1, Page 24) to ( ⇔ Section 7.2.3.2, Page 24) have been observed or carried out.
  1. Undo the fasteners.
  2. Hold the two pipe flanges apart so that the liner will not be damaged.



**7.2.3.3 Removing the valve disc sealing element**

- ✓ The valve is accessible.
- ✓ The valve has been disconnected from the piping on one side at least.
  1. Fully open valve disc 2.
  2. Loosen retaining ring 3.
  3. Undo bolts/screws 11 (TDC01),14 (TDC03).
  4. Remove sealing element 7 (TDC01),10 (TDC03) and retaining ring 3 and clean them.
  5. Clean the valve disc and the seal chamber.
  6. Remove any contamination.

**7.2.3.4 Removing the O-rings**

- ✓ The notes and steps stated in (⇔Section 7.2.3.1, Page 24) to (⇔ Section 7.2.3.2, Page 24) have been observed or carried out.
  1. Fully close valve disc 2.
  2. Remove moving device ( counterweight and/or Hydraulic dumper) .
  3. Remove bolts 12-15 (TDC01), 15-18 (TDC03)
  4. Remove Front and Rear Cover 6-9 (TDC01), 8-9 (TDC03).
  5. Remove O-rings 8 (TDC01), 11-12 (TDC03).

**7.2.4 Assembling the valve**

**7.2.4.1 General information/Safety regulations**

	<b>CAUTION</b>
	<p><b>Improper reassembly</b> Damage to the valve!</p> <ul style="list-style-type: none"> <li>· Reassemble the valve in accordance with the general rules of sound engineering practice.</li> <li>· Use original spare parts only.</li> </ul>

**Tightening torques** Use an appropriate tool to tighten the fasteners crosswise.

**7.2.4.2 Fitting the valve disc sealing element**

- The seal chamber has been cleaned.
  - All dismantled parts have been cleaned and checked for wear.
  - Any damaged or worn parts have been replaced by original spare parts.
1. Apply grease to new valve disc sealing element 7 (TDC01), 10 (TDC03) and place it into the body.
  2. Fit retaining ring 3.
  3. Insert and tighten screws/bolts. ( Section 7.2.5, Page 26, table 6)

**7.2.4.3 Fitting the O-rings**

- The seal chamber has been cleaned.
  - Any damaged or worn parts have been replaced by original spare parts.
1. Grease and insert O-rings 8 (TDC01), 11-12 (TDC03)
  2. Mount the Front and Rear Cover 6-9 (TDC01), 8-9 (TDC03).
  3. Tight bolts 12-15 (TDC01), 15-18 (TDC03) ( section 7.2.5, page 26, table 7)
  4. Mount the counterweight and/or Hydraulic dumper.
  5. Check the position of the valve disc.

**7.2.5 Tightening torques**

**Table 6:** Tightening torques of valve disc screws/bolts [Nm]

Thread size	Tightening torque
M6	5
M8	10
M10	20
M12	32
M16	80

**Table 7:** Tightening torques of bonnet/cover bolts [Nm]

Thread size	Tightening torque
M6	4
M8	8
M10	15
M12	28

## 8 Trouble-shooting

	<b>WARNING</b>
	<p><b>Improper remedial work on the valve</b> Risk of injury!</p> <p>For any work performed in order to remedy faults on the valve observe the relevant information given in this operating manual and/or the product literature provided by the accessories manufacturers.</p>

If problems occur that are not described in the following table, consultation with KSB Service is required.

**Table 8:** Trouble-shooting

Problem	Possible cause	Remedy
Valve noise	Unfavourable installation position causing unfavourable flow around or inside the valve (e.g. insufficient distance from a downstream elbow, etc.)	Change installation position.
	Valve operated beyond its design limits	Check design data and/or operating data; change flow resistance of valve.
Valve cannot be actuated.	Foreign matter jammed in the seat area	Flush valve, dismantle, if necessary, and remove foreign matter.
	Counterweight is blocked.	Deblock.
	Unfavourable flow conditions and restricted movement	Change installation position.
Leakage at the seat/disc interface	Valve not fully closed	Fully close the valve.
	Sealing element damaged or worn	Replace the sealing element.
Cavitation inside the valve	Valve operated beyond its design limits	Valve unsuitable; replace with suitable valve or change operating conditions.
	Operating data changed	
Leakage at the body	Defective sealing elements	Replace sealing elements.
	High external forces	Replace body; check for water hammer.
High actuating forces	Deposits at valve seat	Flush valve, dismantle, if necessary, and clean seat area.
	Dry piping environment, i.e. valve is not in contact with fluid handled.	Verify contact with fluid handled.

## 9 Related Documents

### 9.1 General assembly drawing with list of components

#### COBRA TDC01

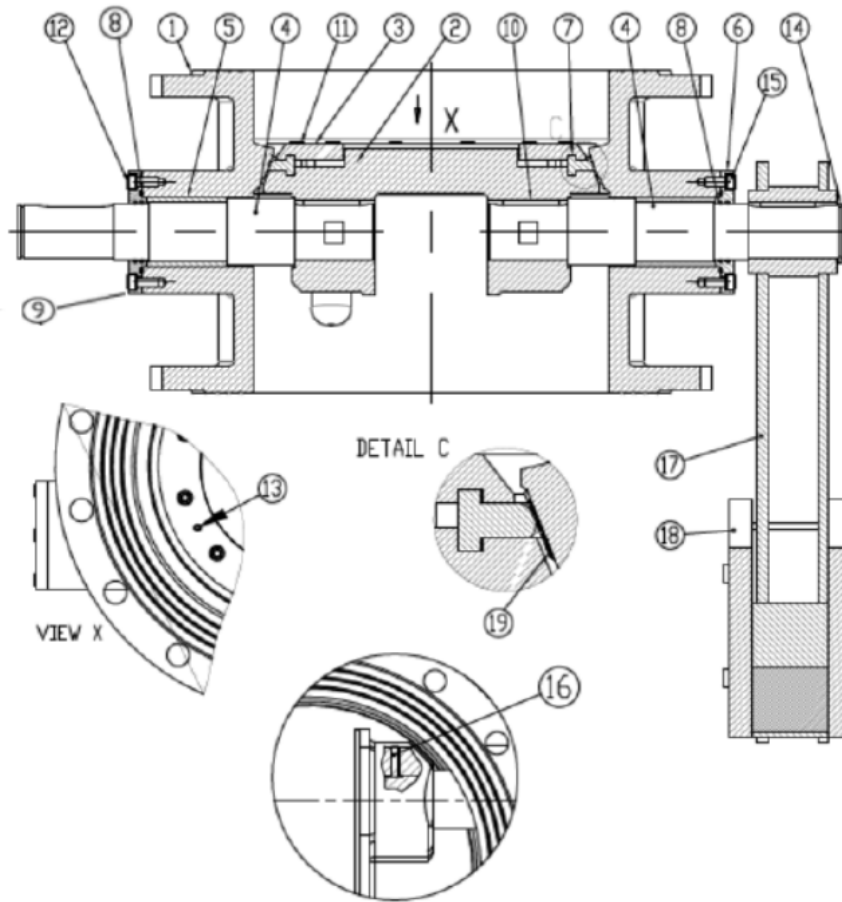

Fig. 4: Exploded view

Table 9: Overview of available materials

Part No.	Description	Material	Material number	Note
1	Body	EN-GJS-400-15		Epoxy-coated
2	Disc	EN-GJS-400-15		Epoxy-coated
3	Retaining ring	AISI 304		-
4	Front-Rear shaft	AISI 420		-
5	Front-rear bearings	G-CuSn10		-
6	Front cover	St-37		Epoxy-coated
7	Seal Ring	EPDM 65-70 shore		-
8	O-Ring	EPDM 65-70 shore		-
9	Rear Cover	St-37		Epoxy.coated
10	Key	Ck 45		-
11	Bolts	A2		-
12	Bolts	A2		-
13	Setscrew	A2		-
14	Snap Ring	Ck 60		-
15	Setscrew	A2		-
16	Setscrew	A2		-
17	Lever	-		-
18	Counterweight	-		
19	Body Seat	AISI 309L		

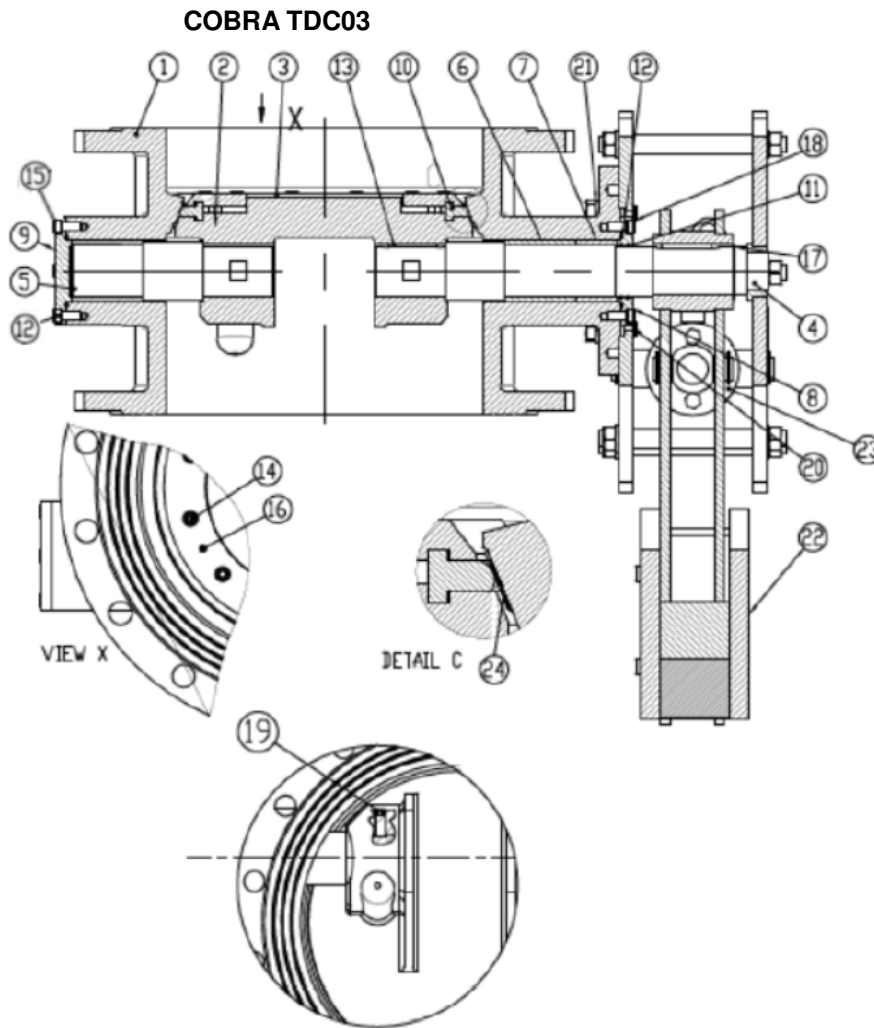

Fig. 4: Exploded view

Table 9: Overview of available materials

Part No.	Description	Material	Material number	Note
1	Body	EN-GJS-400-15		Epoxy-coated
2	Disc	EN-GJS-400-15		Epoxy-coated
3	Retaining ring	AISI 304		-
4	Front shaft	AISI 420		-
5	Rear shaft	AISI 420		-
6	Front-Rear bearings	G-CuSn10		-
7	Spacer bushing	Delrin		-
8	Front cover	St-37		Epoxy-coated
9	Rear cover	St-37		Epoxy-coated
10	Seal ring	EPDM 65-70 shore		-
11-12	O-Ring	EPDM 65-70 shore		-
13	Key	Ck 45		-
14-15	Bolt	A2		-
16	Setscrew	A2		-
17	Snap Ring	Ck 60		-
18-19	Setscrew	A2		-
20	Bolt	A2		-
21	Washer	A2		-
22	Counterweight	-		-
23	Hydraulic damper	-		-
24	Body seat	AISI 309L		-

### 10 Certificate of Decontamination

Type: .....

Order number/ .....

Order item number<sup>10)</sup>: .....

Delivery date: .....

Field of application: .....

Fluid handled<sup>10)</sup>: .....

Please tick where applicable<sup>10)</sup>:



E  
Corrosive



E  
Oxidising



E  
Flammable



E  
Explosive



E  
Hazardous to health



E  
Seriously hazardous to health



E  
Toxic



E  
Radioactive



E  
Hazardous to the environment



E  
Safe

Reason for return<sup>10)</sup>: .....

Comments: .....

.....

The product/accessories have been carefully drained, cleaned and decontaminated inside and outside prior to dispatch/ placing at your disposal.

We herewith declare that this product is free from hazardous chemicals and biological and radioactive substances.

- E No special safety precautions are required for further handling.
- E The following safety precautions are required for flushing fluids, fluid residues and disposal:

.....

.....

We confirm that the above data and information are correct and complete and that shipping is effected in accordance with the relevant legal provisions.

.....  
Place, date and signature

.....  
Address

.....  
Company stamp

10) Required fields

**Index****C**

Certificate of Decontamination 30  
Commissioning/start-up 20

**D**

Dead-end valve 16  
Design 14  
Dismantling 24  
Disposal 13

**E**

Event of damage 24

**F**

Faults  
    Causes and remedies 27  
Fitting the O-rings 26  
Fitting the valve disc sealing element 26  
Flange connection 18  
Flow velocity 21  
Function 15

**I**

Installation position 16  
Insulation 19  
Intended use 8

**K**

Key to safety symbols/markings 7

**M**

Maintenance 23

**N**

Noise characteristic 15

**O**

Operating limits 8, 21  
Other applicable documents 6

**P**

Partly completed machinery 6  
Piping 17  
Preservation 11  
Pressure/temperature ratings 21  
Product description 14

**R**

Removing the O-ring 25  
Removing the valve disc sealing element 25  
Return to supplier 12  
Returning to service 22

**S**

Safety 8  
Safety awareness 9  
Scope of supply 15  
Shutdown 22  
Storage 11

**T**

Tightening torques 26  
Transport 11

**W**

Warnings 7

**KSB SE & Co. KGaA**

Johann-Klein-Straße 9 • 67227 Frankenthal (Germany)

Tel. +49 6233 86-0

[www.ksb.com](http://www.ksb.com)

**KSB Italia S.p.A.**

Via Massimo D'Azeglio, 32

20863 Concorezzo MB

Tel. +39 039 6048-000 – Fax +39 039 6048-097

[www.ksb.com](http://www.ksb.com)

Centri Service

Concorezzo MB • Via Massimo D'Azeglio, 32

Tel. +39 039 6048-000 • Fax +39 039 6048-882

Scorzè VE • Via Guido Rossa, 12/A

Tel. +39 041 5840917 • Fax +39 041 5840918

