

Etaseco
 Normpumpen
 Standardized Pumps
 Pompes normalisées
 Pompe normalizzate
 Standaardpompen
 Bombas estandarizadas

Etaseco - I
 Inline-Pumpen
 Inline-Pumps
 Pompes Inline
 Pompe Inline
 Inline-Pompen
 Bombas Inline

50 Hz = 2900 1/min

Etaseco	Q _{opt.}	Werkstoff G	Werkstoff S
	m ³ /h	Seite Page Page Pagina Bladzijde Pagina	Seite Page Page Pagina Bladzijde Pagina
32-125.1	19	7	7
32-160.1	19	8	8
32-200.1	16	9	9
32-250.1	17	10	-
32-125	26	11	-
32-160	26	12	12
32-200	28	13	13
32-250	26	14	14
40-125	46	15	-
40-160	50	16	16
40-200	44	17	17
40-250	50	18	18
50-125	82	19	-
50-160	86	20	20
50-200	80	21	21
65-125	120	22	-
65-160	120	23	23
65-200	121	24	24
80-160	210	25	25

Etaseco - I	Werkstoff G		Werkstoff S	
	Q _{opt.}	Seite Page Page Pagina Bladzijde Pagina	Q _{opt.}	Seite Page Page Pagina Bladzijde Pagina
	m ³ /h		m ³ /h	
32-160	22	26	-	-
32-200	26	27	-	-
40-160	26	28	18	37
40-200	-	-	15	38
40-250	44	29	-	-
50-160	43	30	26	39
50-200	-	-	25	40
50-250	62	31	-	-
65-160	75	32	43	41
65-200	-	-	38	42
65-250	91	33	-	-
80-160	101	34	62	43
80-200	-	-	80	44
80-210	103	35	-	-
100-160	104	36	100	45

Die in den Kennlinienblättern angegebenen NPSH-Werte sind Minimalwerte, die der Kavitationsgrenze entsprechen; sie gelten für entgastes Wasser.

Aus Sicherheitsgründen sind daher die Kurvenwerte für die Anwendung um mindestens 0,5 m zu erhöhen.

Garantien der Meßwerte in den Kennlinien nach DIN 1944/III. Die Förderhöhen und Leistungsangaben gelten für Fördermedien mit der Dichte $\rho = 1,0 \text{ kg/dm}^3$ und eine kinematische Viskosität ν bis $20 \text{ mm}^2/\text{s}$.

Ist die Dichte $\rho \neq 1,0$, dann muß die Leistungsangabe mit ρ multipliziert werden.

The NPSH values given in the performance curve sheets are minimum values which correspond to the inception of cavitation, they apply to degassed water.

For reasons of safety the curve values must, therefore, be increased by at least 0.5 m for application.

For guarantees of measured values see performance curves to DIN 1944/III.

The total heads and the performance characteristics refer to mediums compressed with $\rho = 1.0 \text{ kg/dm}^3$ and a kinematic viscosity ν up to $20 \text{ mm}^2/\text{s}$.

If the density $\rho \neq 1.0$, the performance characteristics are to be multiplied by ρ .

Les valeurs du NPSH indiquées par les feuilles de courbes sont des valeurs minimales qui correspondent à la limite de cavitation; elles concernent le pompage d'eau dégazée.

Pour des raisons de sécurité, les valeurs de la courbe sont à augmenter d'au moins 0,5 m pour l'application.

Valeurs mesurées des courbes garanties selon DIN 1944/III.

Les caractéristiques de la pompe indiquées sont valables pour un fluide pompé d'une densité égale à 1 kg/dm^3 , et pour une viscosité cinématique n'excédant pas $20 \text{ mm}^2/\text{s}$.

Si la densité du fluide pompé a une valeur différente de 1,0, multiplier par cette valeur les caractéristiques indiquées.

I valori di NPSH indicati nei fogli delle curve sono valori minimi, che corrispondono al limite della cavitazione; essi valgono per acqua degasata.

Per motivi di sicurezza i valori delle curve devono quindi venir aumentati di 0,5 m per l'impiego pratico.

I valori misurati delle curve sono garantiti secondo DIN 1944/III. Le prevalenze e le potenze indicate valgono per liquidi con densità $\rho = 1,0 \text{ kg/dm}^3$ ed una viscosità cinematica ν sino a $20 \text{ mm}^2/\text{sec}$. al massimo.

Se la densità $\rho \neq 1,0$, la potenza indicata deve venir moltiplicata per ρ .

De in de grafieken aangegeven NPSH-waarden zijn minimale waarden die overeenkomen met de kavitatiegrenzen; zij gelden voor niet gashoudend water.

Uit veiligheidsoverwegingen dienen de grafiekwaarden voor de toepassing met tenminste 0,5 m verhoogt te worden.

De meetwaarden in de grafieken voldoen aan DIN 1944/III.

De obvoerhoogten en afgegeven vermogens gelden voor media met een dichtheid $\rho = 1,0 \text{ kg/dm}^3$ en een kinematische viscositeit ν tot max. $20 \text{ mm}^2/\text{s}$.

Als de dichtheid $\rho \neq 1,0$, dan dient het afgegeven vermogen met ρ vermenigvuldigt te worden.

Los valores NPSH indicados en las hojas de curvas características son valores mínimos que corresponden al límite de cavitación y rigen para agua desgasificada.

En la práctica, los valores de las curvas deben aumentarse por lo menos 0,5 m por razones de seguridad.

Garantías de los valores de medición en las curvas características según DIN 1944/III.

Las alturas manométricas y las indicaciones sobre potencias requeridas valen para líquidos de elevación con densidad $\rho = 1,0 \text{ kg/dm}^3$ y una viscosidad cinemática hasta un máximo de $20 \text{ mm}^2/\text{s}$.

Si la densidad $\rho \neq 1,0$ debe multiplicarse la potencia indicada por ρ .

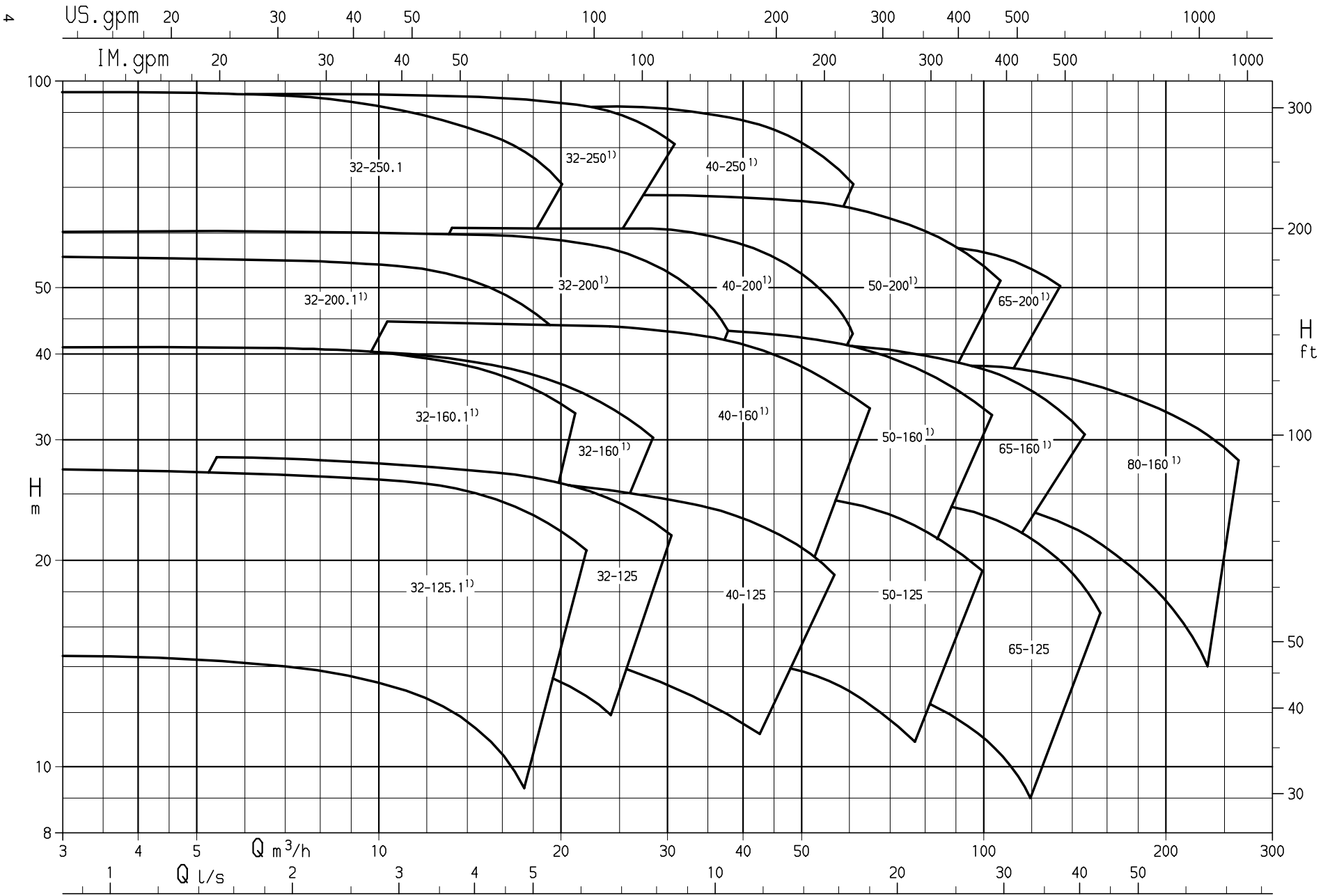

2935.451

Lieferbar auch in: Also available in: Egalement livrable en: Anche consegnabile in: Ook leverbaar in: También disponible en:

1) Shäroguß / Spheroidal graphite cast iron / Fonte nodulaire / Ghisa sferoidale / Nodulair gietijzer / Fundición esferoidal

Etaseco G - I
n = 2900 1/min

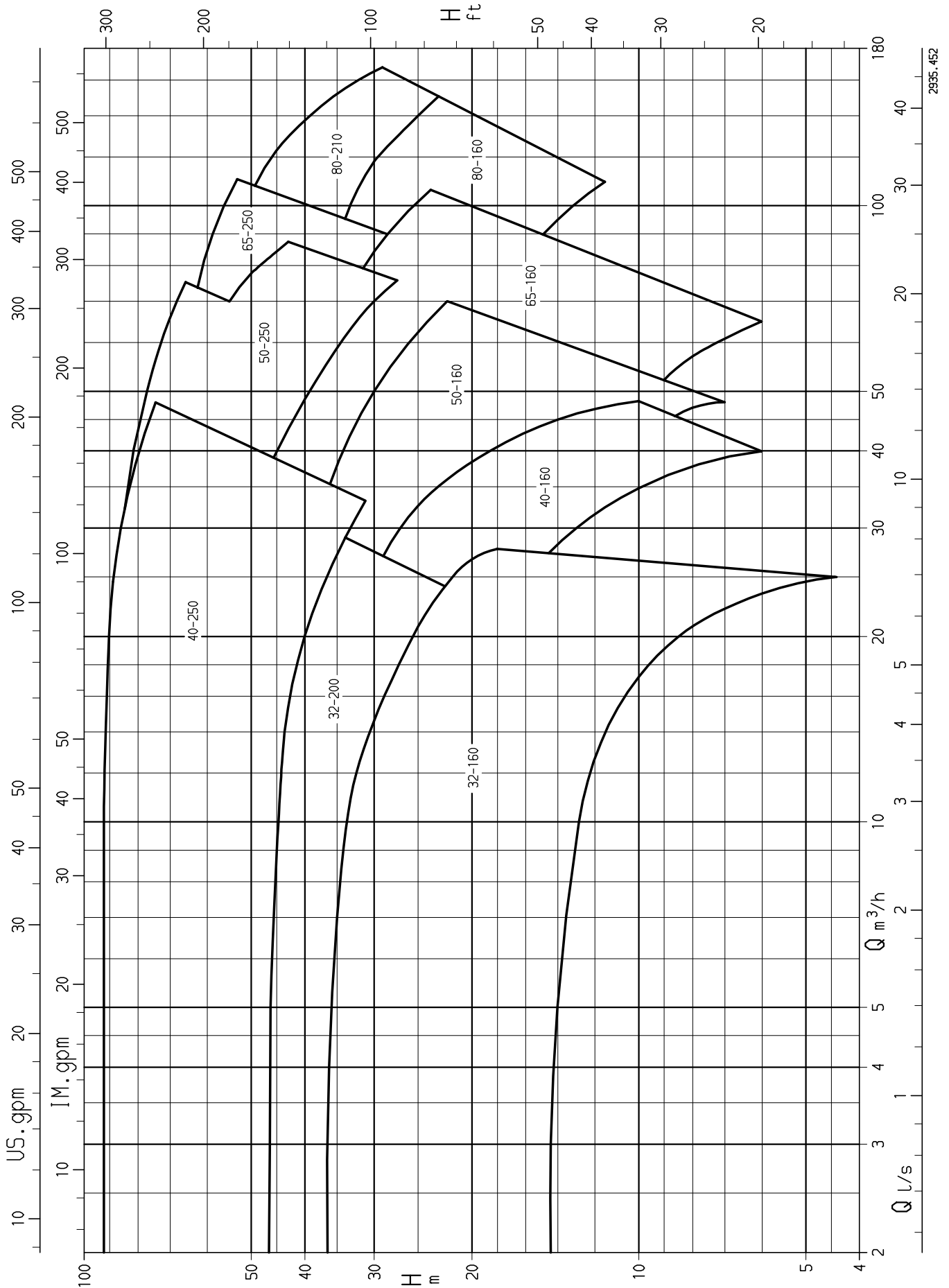

Etaseco S - I
n = 2900 1/min

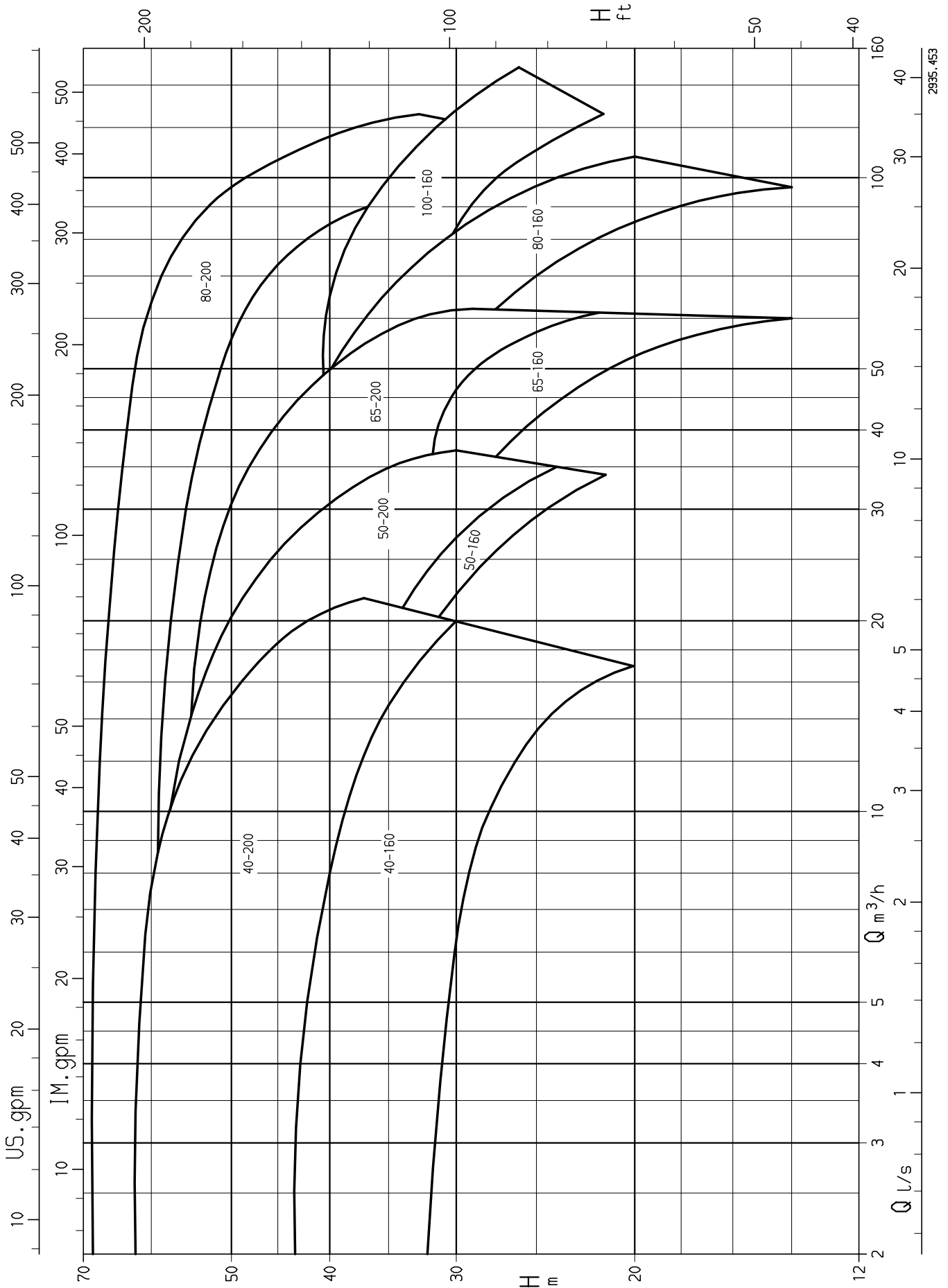

Baureihe Pump type Modèle	Tipo Serie Tipo	Nennndrehzahl Nom. speed Vitesse nom.	Velocità di rotazione nom. Nominaal toerental Revoluciones nom.	 KSB Aktiengesellschaft Pumpen Industrie- und Wassertechnik Postfach 13 60, D-91253 Pegnitz Bahnhofplatz 1, D-91257
Etaseco G, S 32-125.1		2900 1/min		
Angebots-Nr. Project No. No. de l'offre	Offerta-No. Offertenr. Oferta-No.	Pos.-Nr. Item No. No. de pos.	Pos.-Nr. Positiennr. Pos.-Nr.	

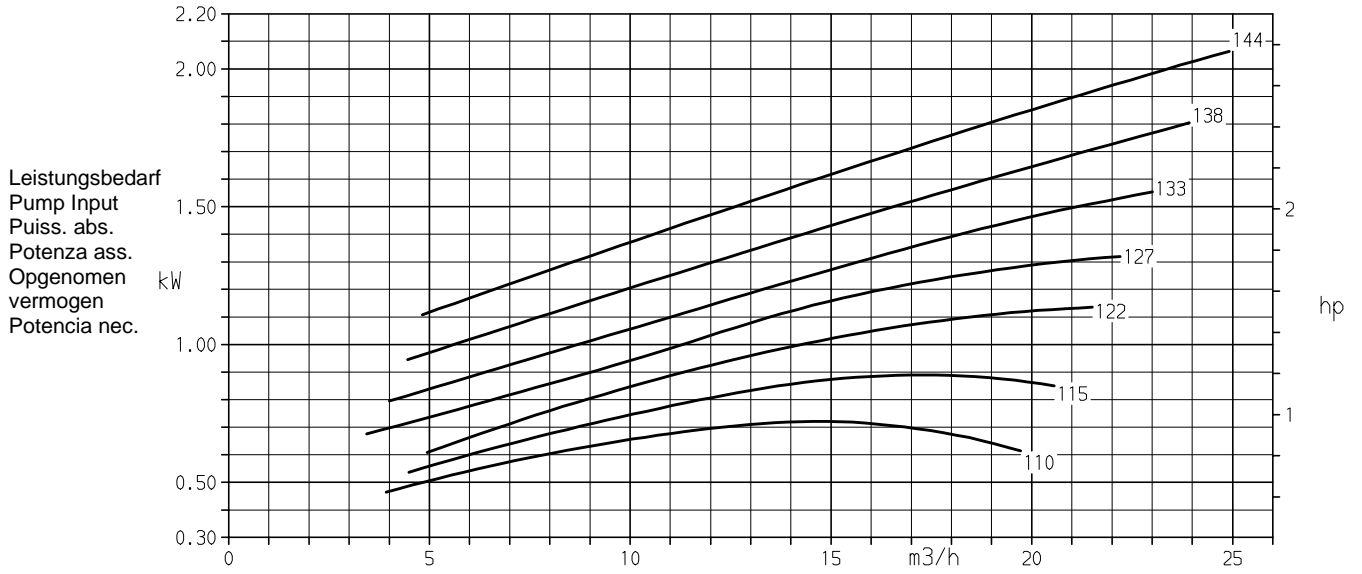
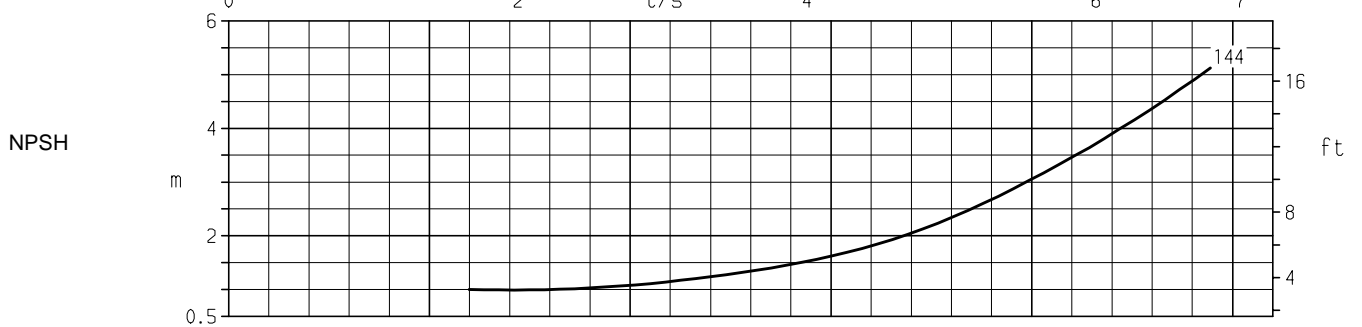
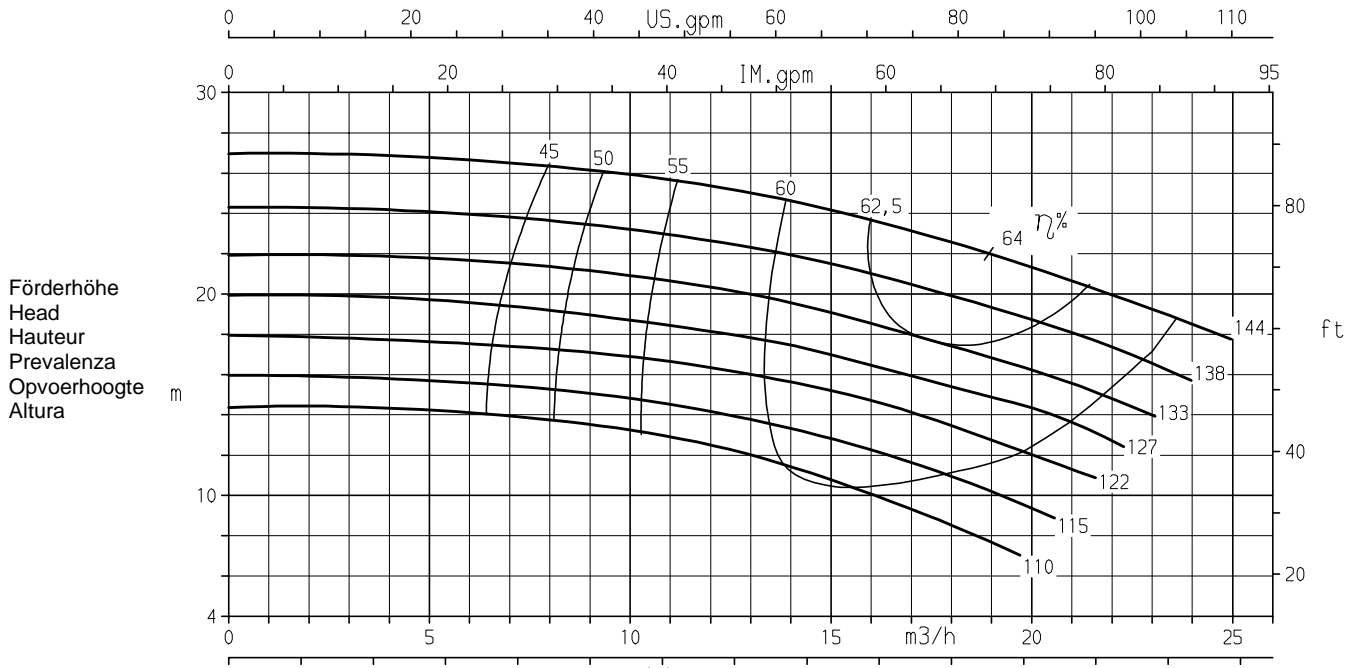

K2935. 101

Förderstrom/Capacity/Débit/Portata/Kapaciteit/Caudal

Baureihe Pump type Modèle	Tipo Serie Tipo	Nenndrehzahl Nom. speed Vitesse nom.	Velocità di rotazione nom. Nominaal toerental Revoluciones nom.	 KSB Aktiengesellschaft Pumpen Industrie- und Wassertechnik Postfach 13 60, D-91253 Pegnitz Bahnhofplatz 1, D-91257
Etaseco G, S 32-160.1		2900 1/min		
Angebots-Nr. Project No. No. de l'offre	Offerta-No. Offertenr. Oferta-No.	Pos.-Nr. Item No. No. de pos.	Pos.-Nr. Positiennr. Pos.-Nr.	

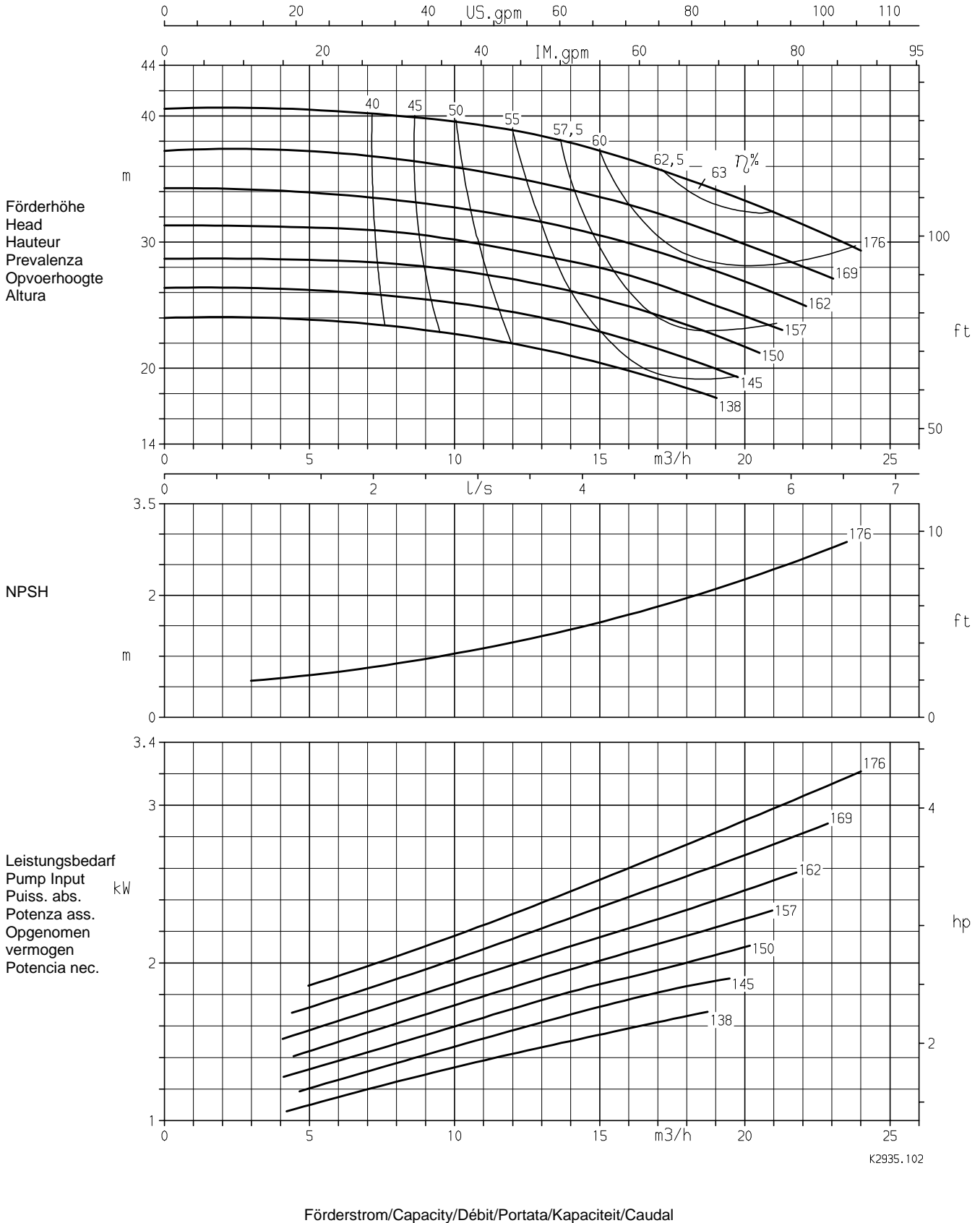

K2935.102

Baureihe Pump type Modèle	Tipo Serie Tipo	Nennzahl Nom. speed Vitesse nom.	Velocità di rotazione nom. Nominaal toerental Revoluciones nom.	 KSB KSB Aktiengesellschaft Pumpen Industrie- und Wassertechnik Postfach 13 60, D-91253 Pegnitz Bahnhofplatz 1, D-91257
Etaseco G, S	32-200.1	2900 1/min		
Angebots-Nr. Project No. No. de l'offre	Offerta-No. Offertenr. Oferta-No.	Pos.-Nr. Item No. No. de pos.	Pos.-Nr. Positiennr. Pos.-Nr.	

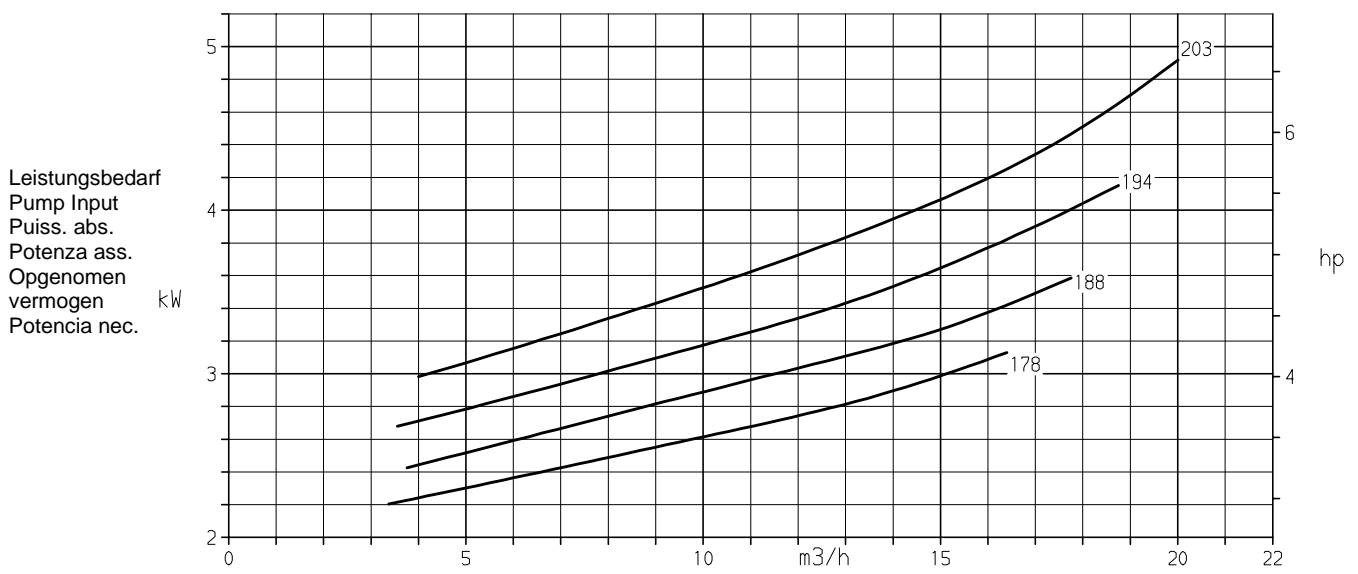
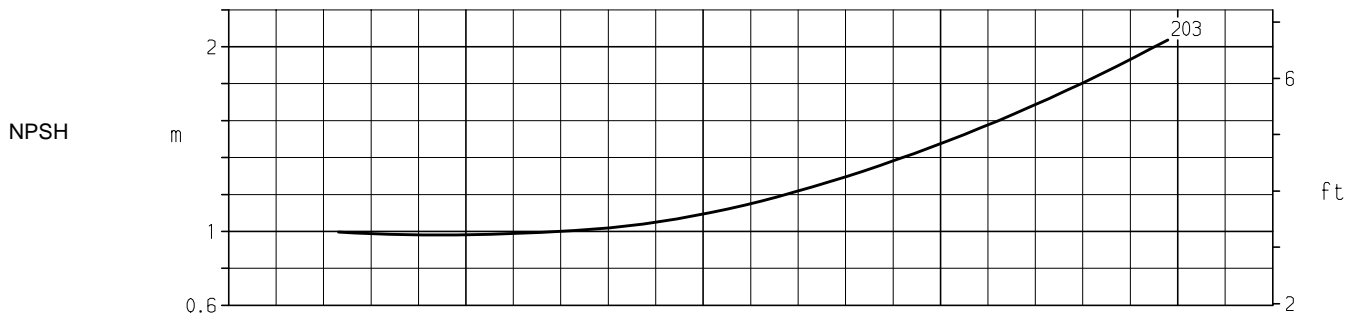
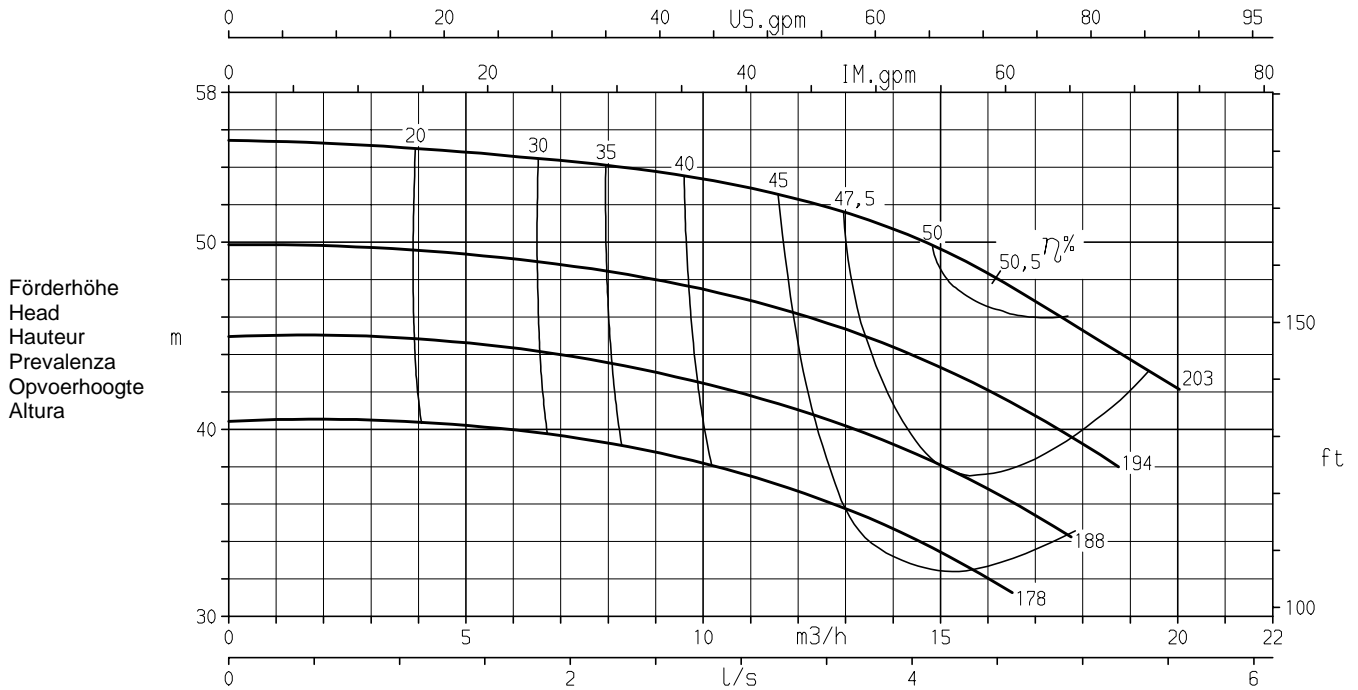

K2935.103

Förderstrom/Capacity/Débit/Portata/Kapaciteit/Caudal

Baureihe Pump type Modèle	Tipo Serie Tipo	Nenndrehzahl Nom. speed Vitesse nom.	Velocità di rotazione nom. Nominaal toerental Revoluciones nom.	 KSB Aktiengesellschaft Pumpen Industrie- und Wassertechnik Postfach 13 60, D-91253 Pegnitz Bahnhofplatz 1, D-91257
Etaseco G	32-250.1	2900 1/min		
Angebots-Nr. Project No. No. de l'offre	Offerta-No. Offertenr. Oferta-No.	Pos.-Nr. Item No. No. de pos.	Pos.-Nr. Positiönr. Pos.-Nr.	

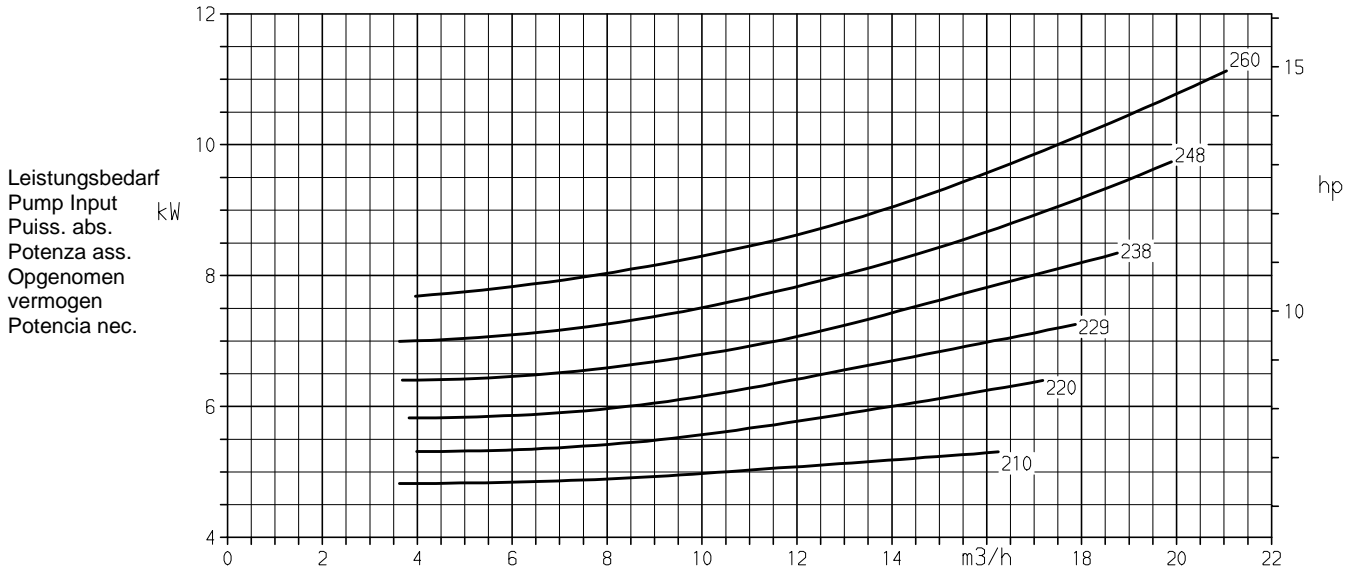
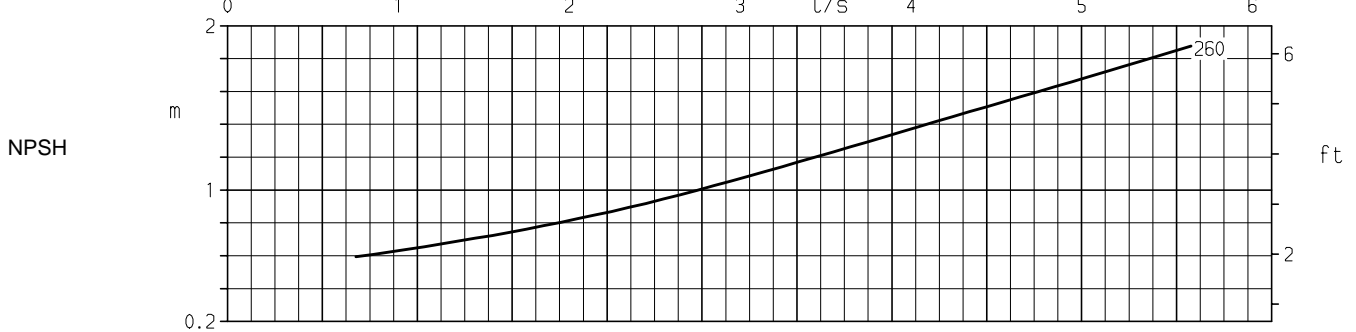
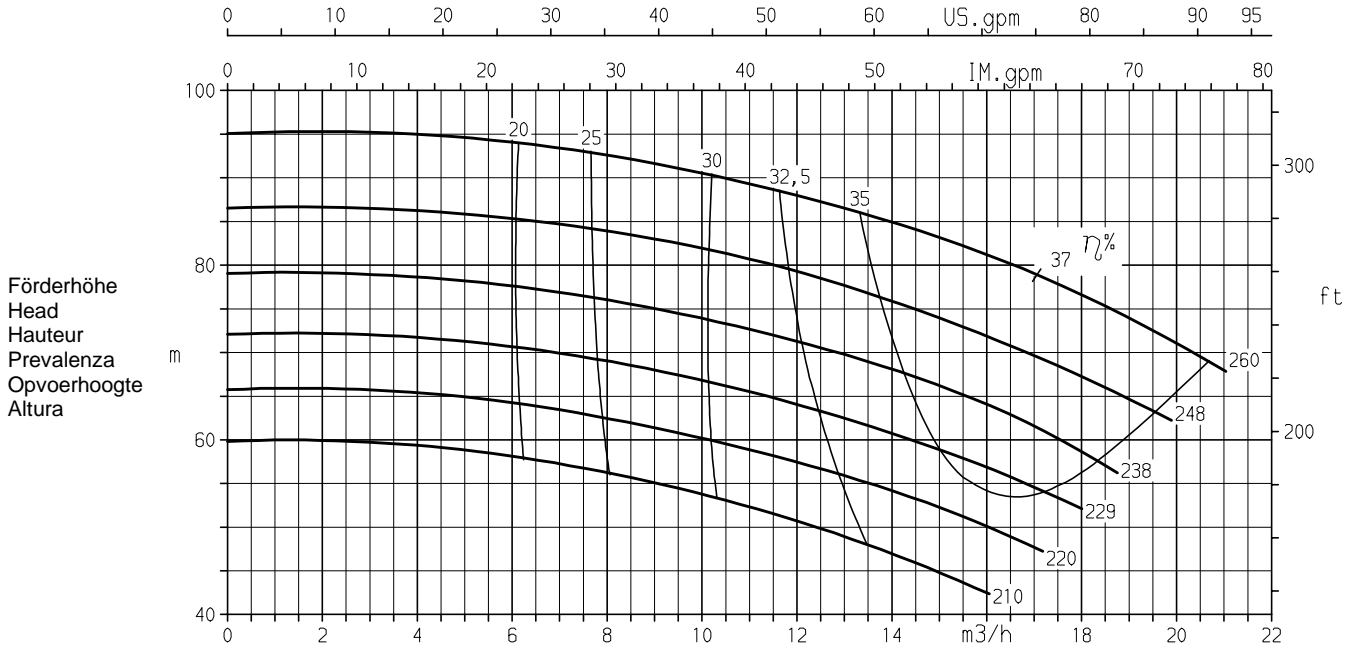

K2935.104

Förderstrom/Capacity/Débit/Portata/Kapaciteit/Caudal

Baureihe Pump type Modèle	Tipo Serie Tipo	Nenn Drehzahl Nom. speed Vitesse nom.	Velocità di rotazione nom. Nominaal toerental Revoluciones nom.	 KSB KSB Aktiengesellschaft Pumpen Industrie- und Wassertechnik Postfach 13 60, D-91253 Pegnitz Bahnhofplatz 1, D-91257
Etaseco G	32-125	2900 1/min		
Angebots-Nr. Project No. No. de l'offre	Offerta-No. Offertenr. Oferta-No.	Pos.-Nr. Item No. No. de pos.	Pos.-Nr. Positiennr. Pos.-Nr.	

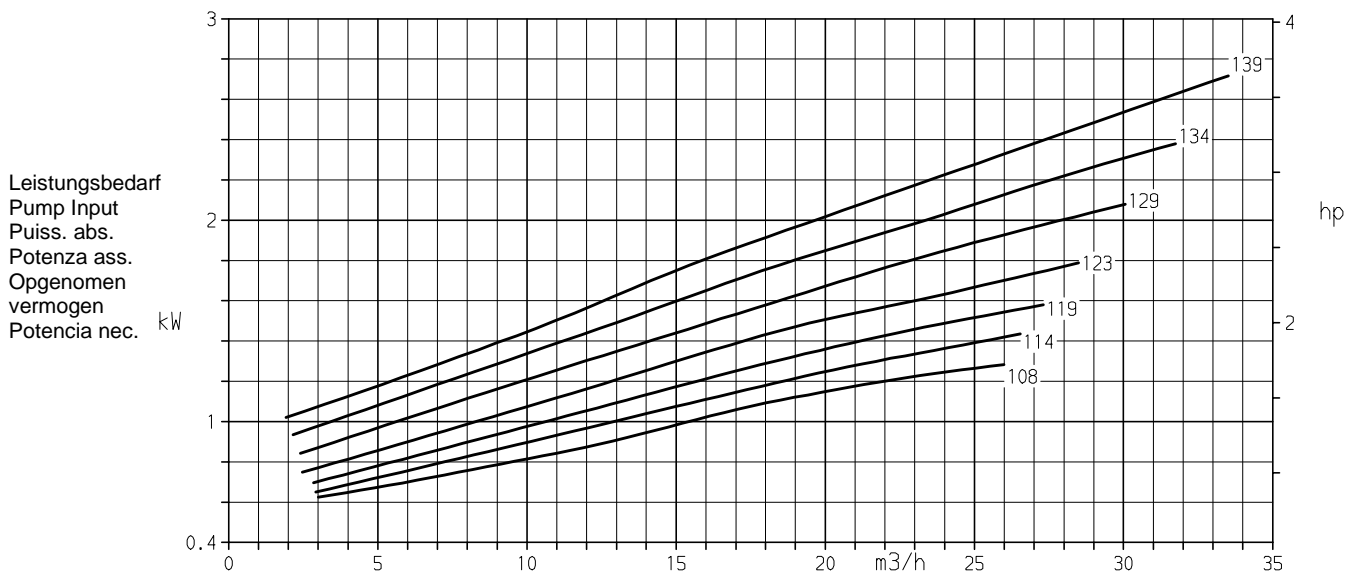
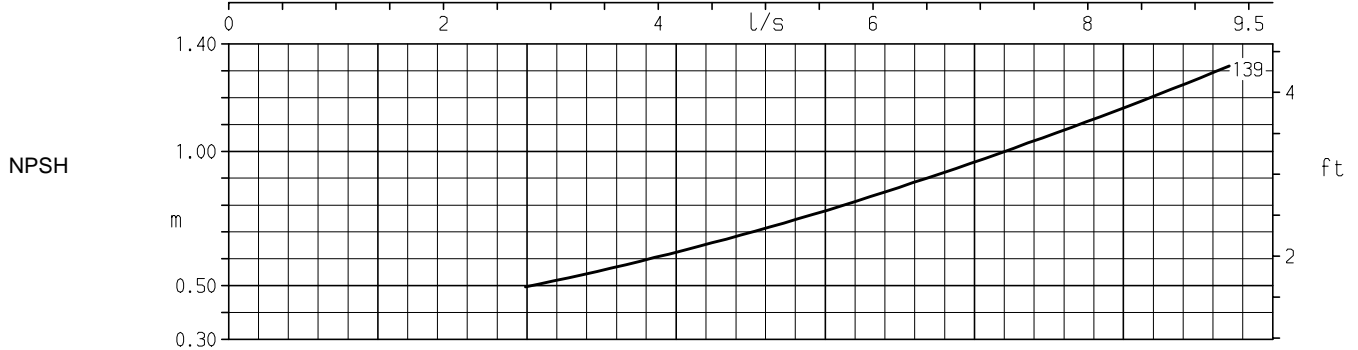
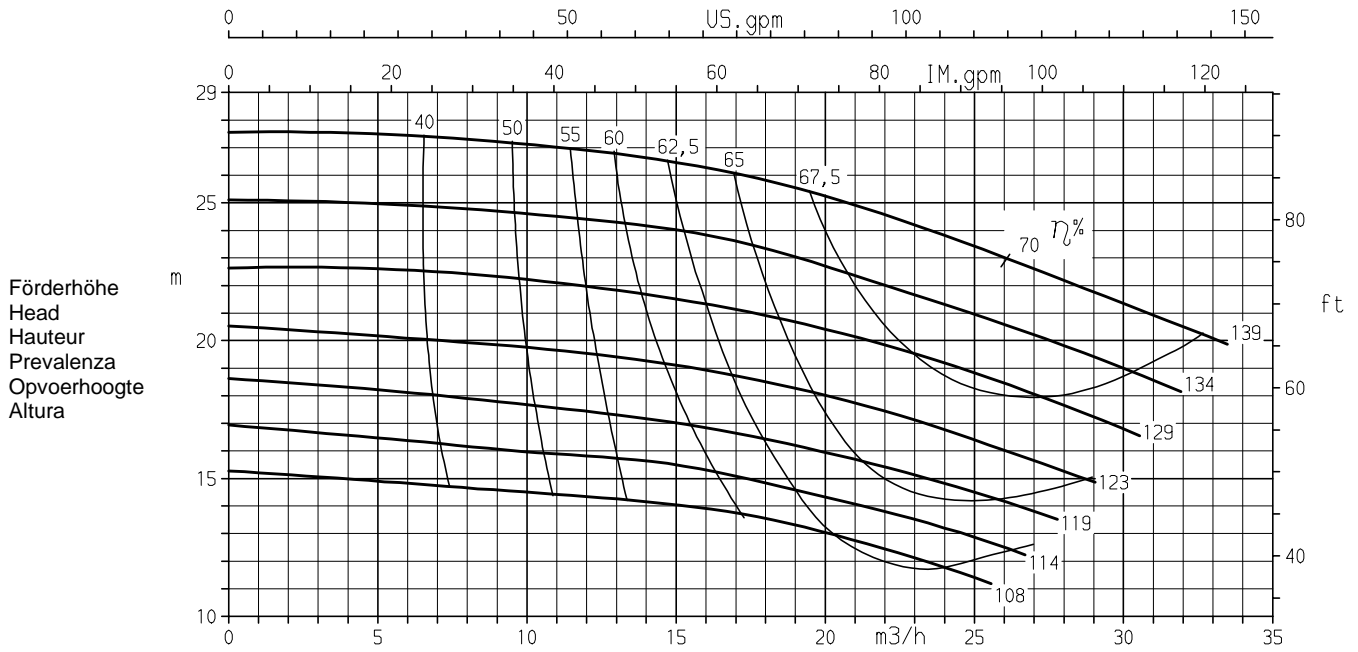

K2935.105

Förderstrom/Capacity/Débit/Portata/Kapazität/Caudal

Baureihe Pump type Modèle	Tipo Serie Tipo	Nenndrehzahl Nom. speed Vitesse nom.	Velocità di rotazione nom. Nominaal toerental Revoluciones nom.	 KSB KSB Aktiengesellschaft Pumpen Industrie- und Wassertechnik Postfach 13 60, D-91253 Pegnitz Bahnhofplatz 1, D-91257
Etaseco G, S	32-160	2900 1/min		
Angebots-Nr. Project No. No. de l'offre	Offerta-No. Offertenr. Oferta-No.	Pos.-Nr. Item No. No. de pos.	Pos.-Nr. Positiönr. Pos.-Nr.	

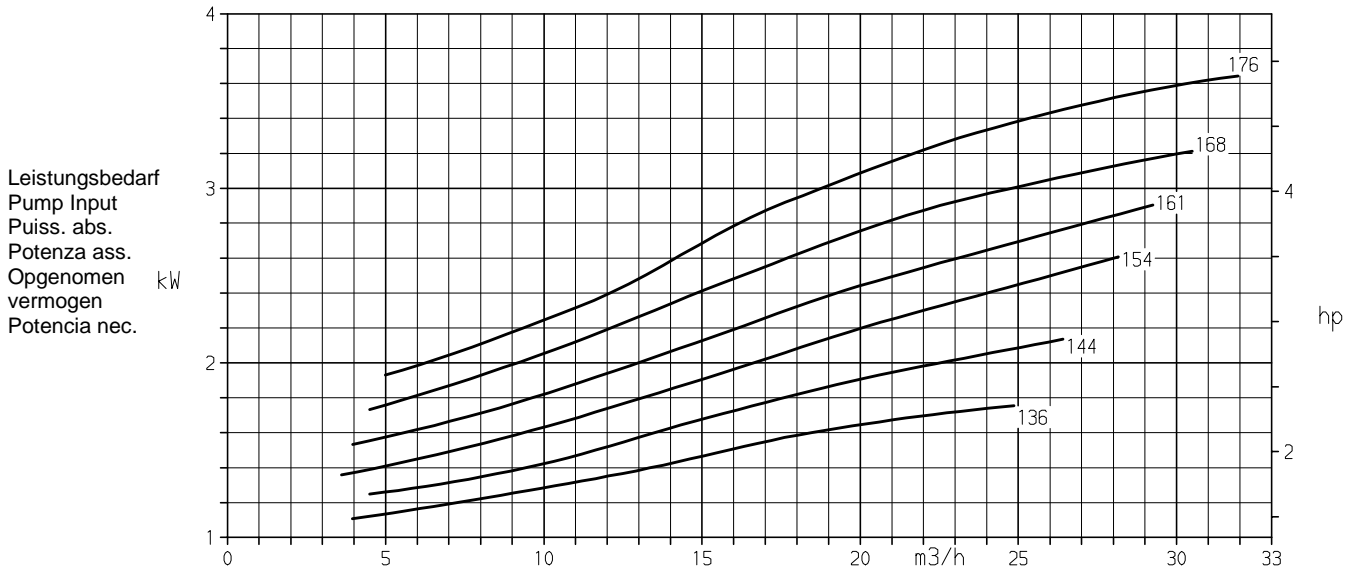
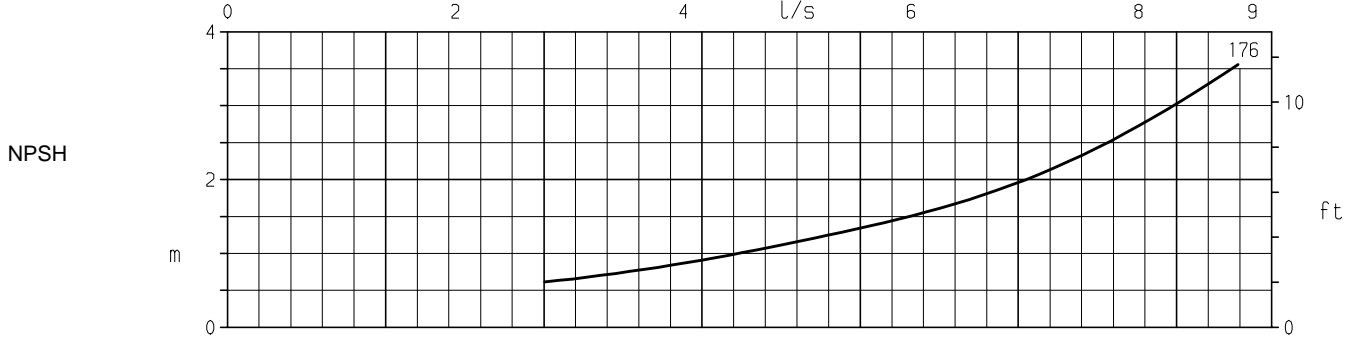
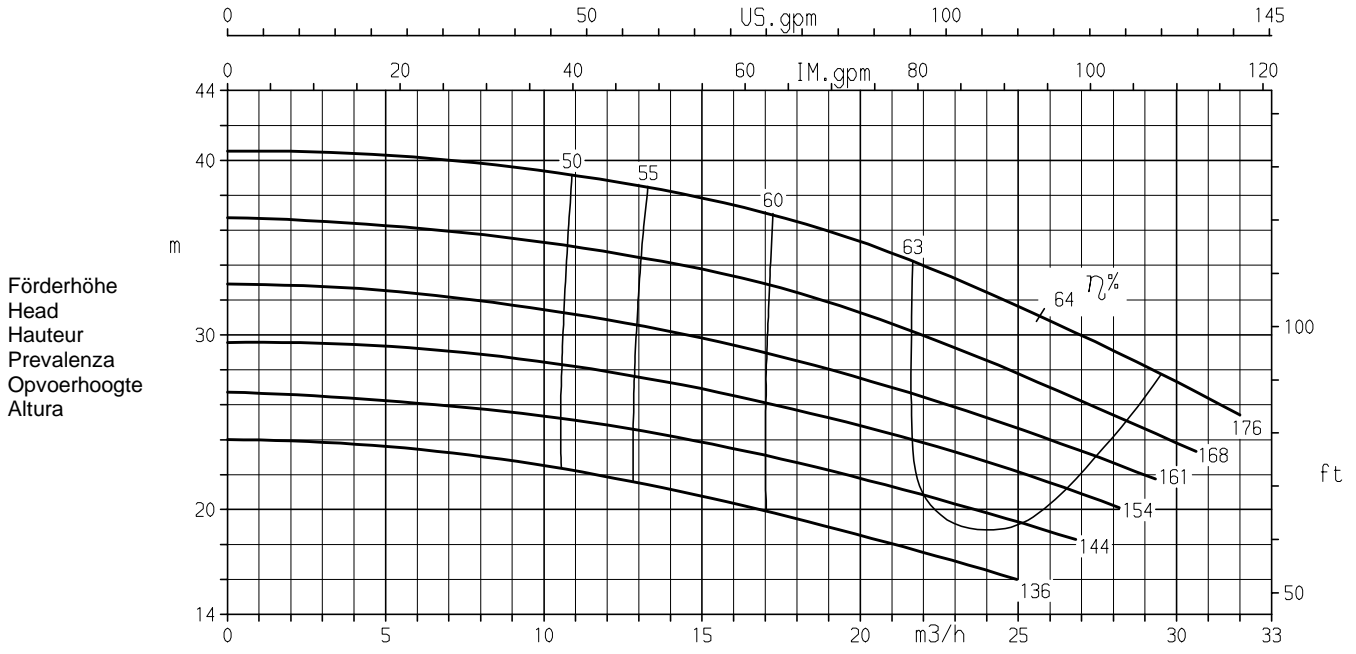

K2935.106

Förderstrom/Capacity/Débit/Portata/Kapaciteit/Caudal

Baureihe Pump type Modèle	Tipo Serie Tipo	Nenndrehzahl Nom. speed Vitesse nom.	Velocità di rotazione nom. Nominaal toerental Revoluciones nom.	 KSB KSB Aktiengesellschaft Pumpen Industrie- und Wassertechnik Postfach 13 60, D-91253 Pegnitz Bahnhofplatz 1, D-91257
Etaseco G, S	32-200	2900 1/min		
Angebots-Nr. Project No. No. de l'offre	Offerta-No. Offertenr. Oferta-No.	Pos.-Nr. Item No. No. de pos.	Pos.-Nr. Positiönr. Pos.-Nr.	

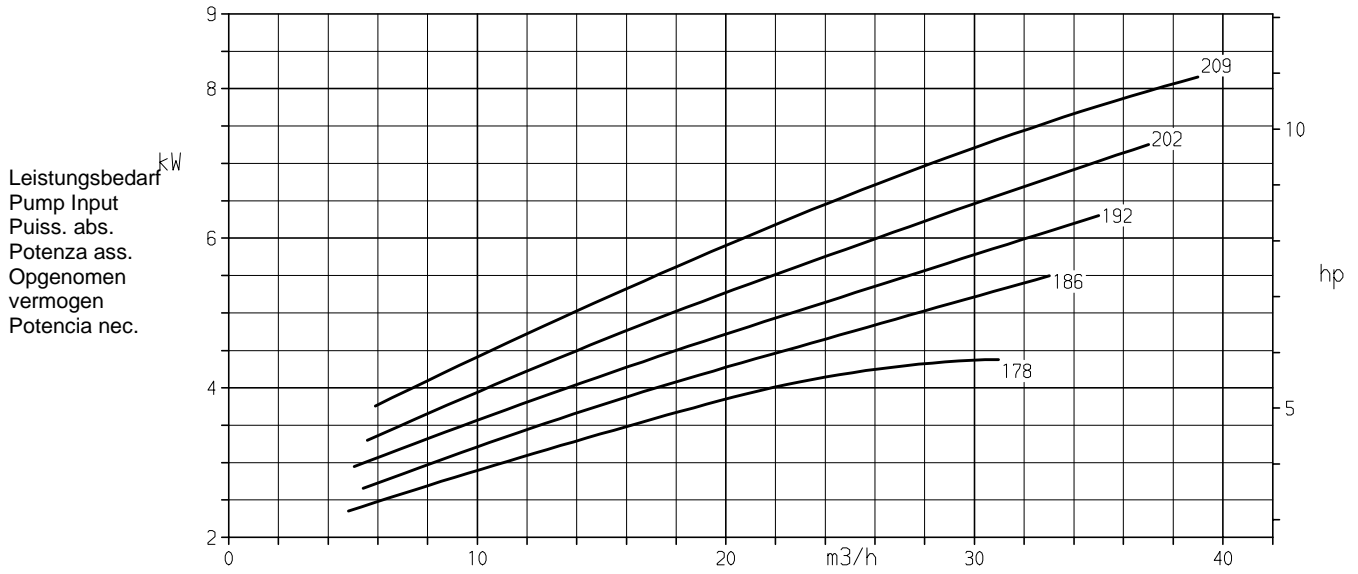
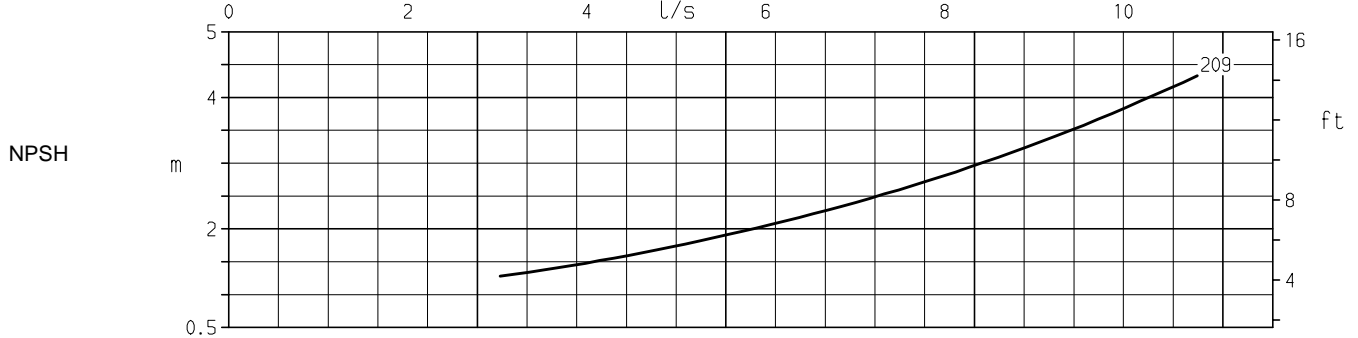
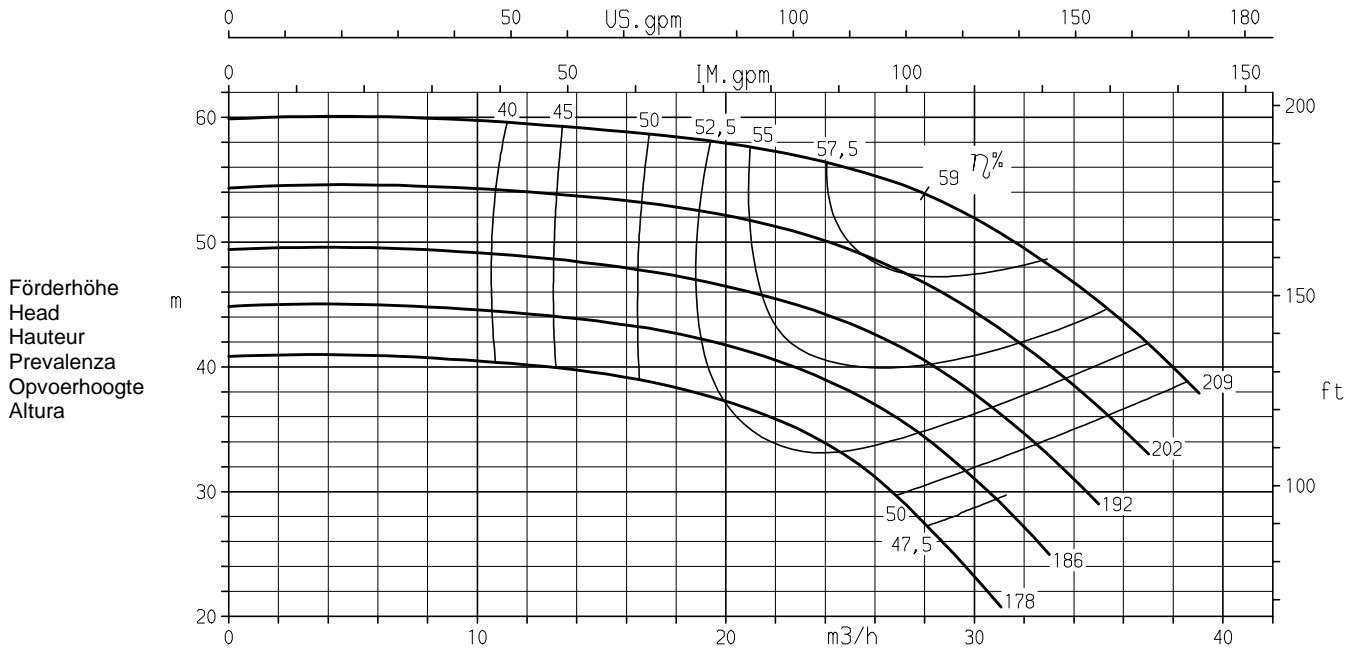

K2935.107

Förderstrom/Capacity/Débit/Portata/Kapaciteit/Caudal

Baureihe Pump type Modèle	Tipo Serie Tipo	Nenndrehzahl Nom. speed Vitesse nom.	Velocità di rotazione nom. Nominaal toerental Revoluciones nom.	 KSB KSB Aktiengesellschaft Pumpen Industrie- und Wassertechnik Postfach 13 60, D-91253 Pegnitz Bahnhofplatz 1, D-91257
Etaseco G, S	32-250	2900 1/min		
Angebots-Nr. Project No. No. de l'offre	Offerta-No. Offertenr. Oferta-No.	Pos.-Nr. Item No. No. de pos.	Pos.-Nr. Positiennr. Pos.-Nr.	

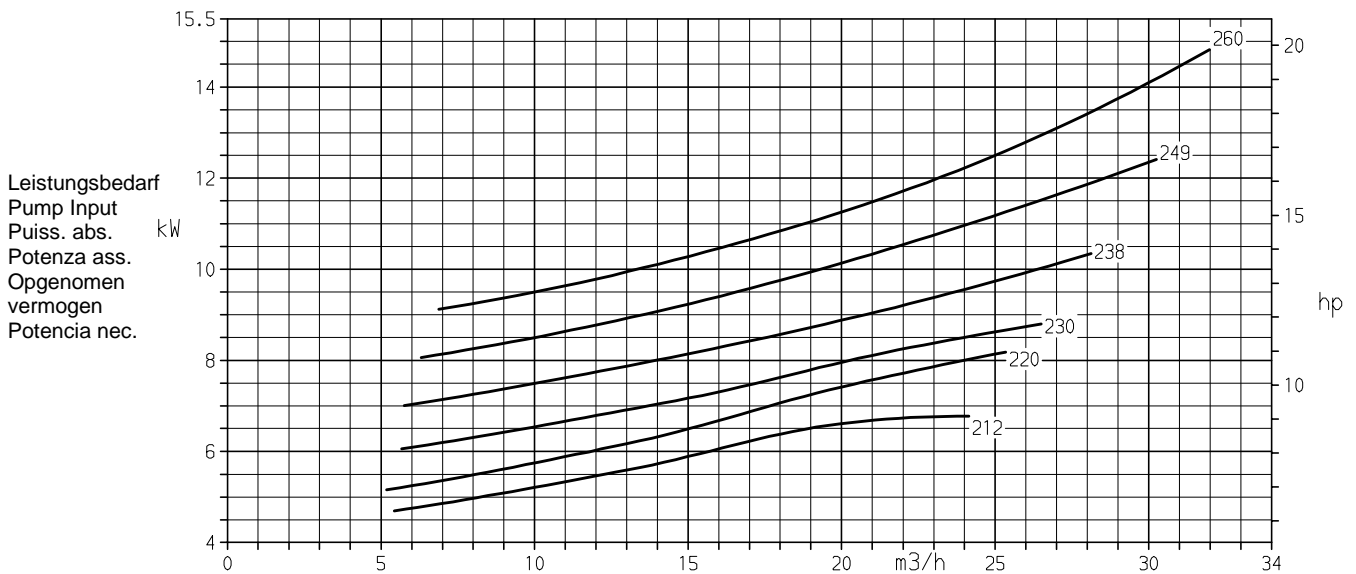
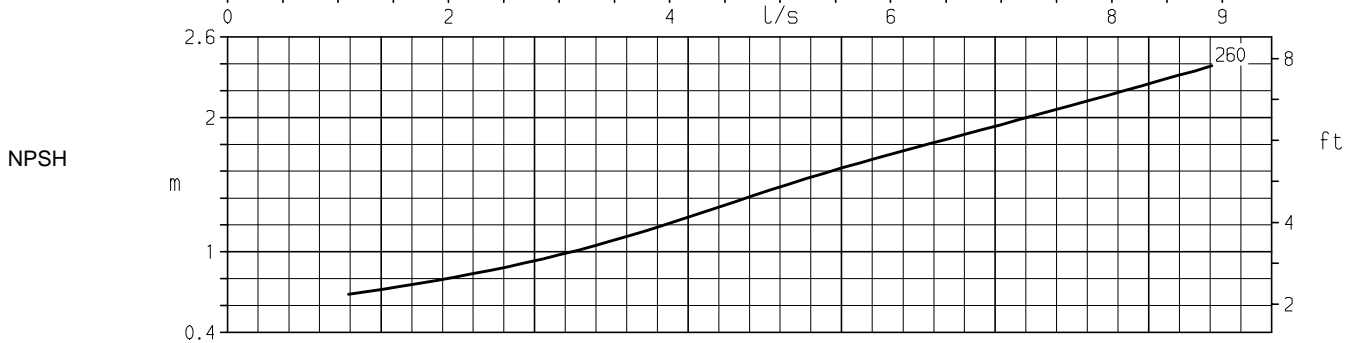
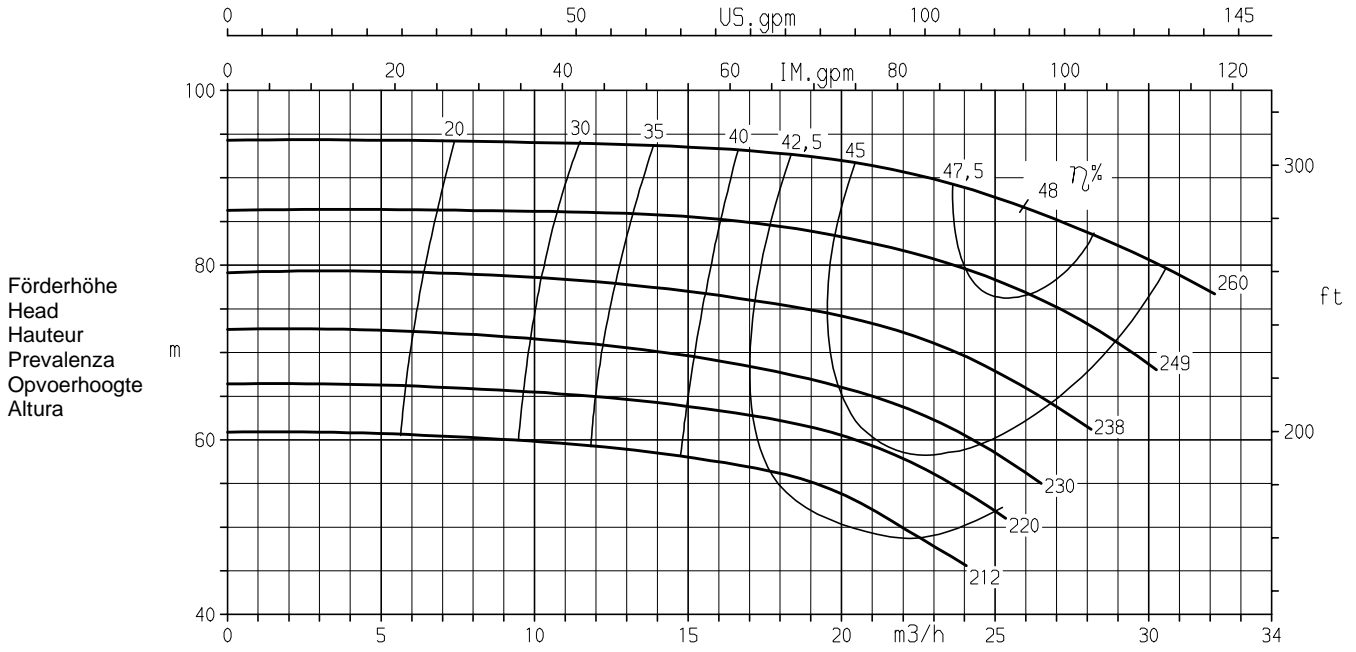

K2935.108

Förderstrom/Capacity/Débit/Portata/Kapaciteit/Caudal

Baureihe Pump type Modèle	Tipo Serie Tipo	Nenn Drehzahl Nom. speed Vitesse nom.	Velocità di rotazione nom. Nominaal toerental Revoluciones nom.	 KSB KSB Aktiengesellschaft Pumpen Industrie- und Wassertechnik Postfach 13 60, D-91253 Pegnitz Bahnhofplatz 1, D-91257
Etaseco G	40-125	2900 1/min		
Angebots-Nr. Project No. No. de l'offre	Offerta-No. Offertenr. Oferta-No.	Pos.-Nr. Item No. No. de pos.	Pos.-Nr. Positiennr. Pos.-Nr.	

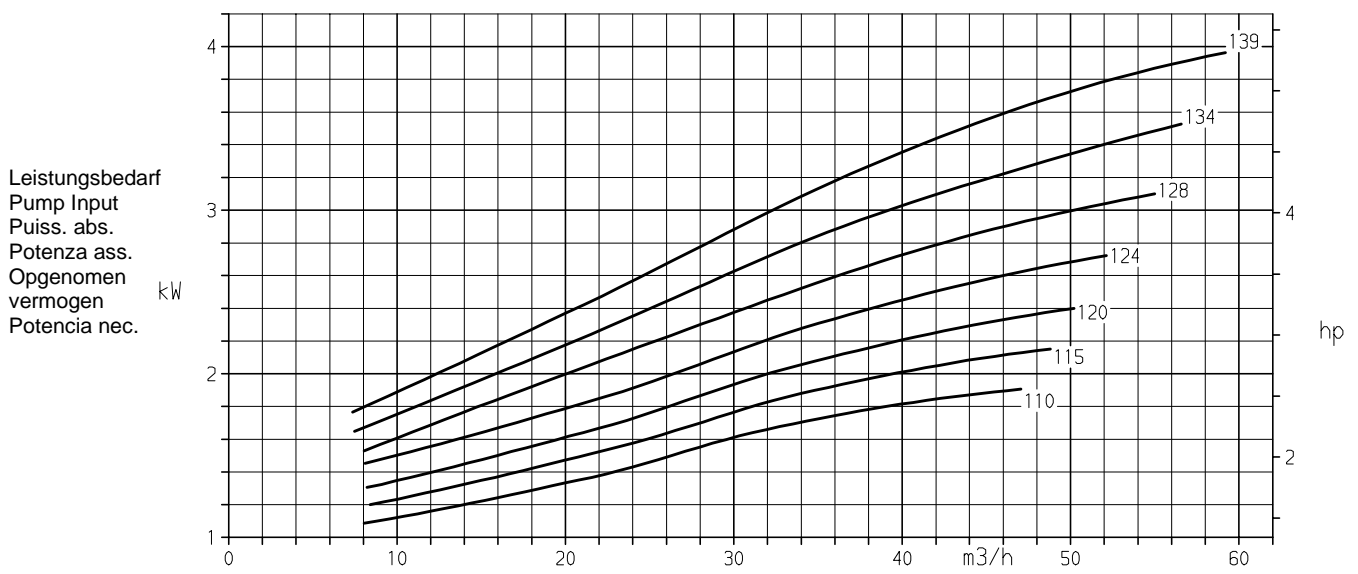
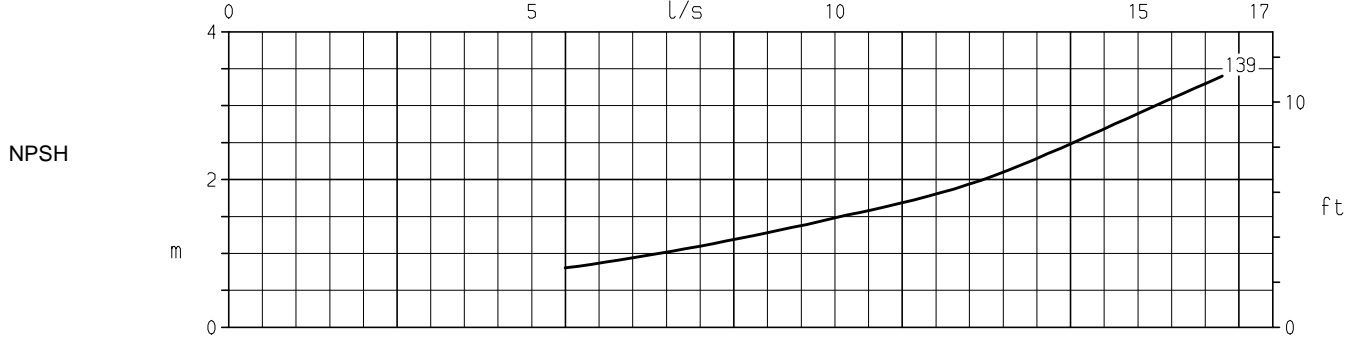
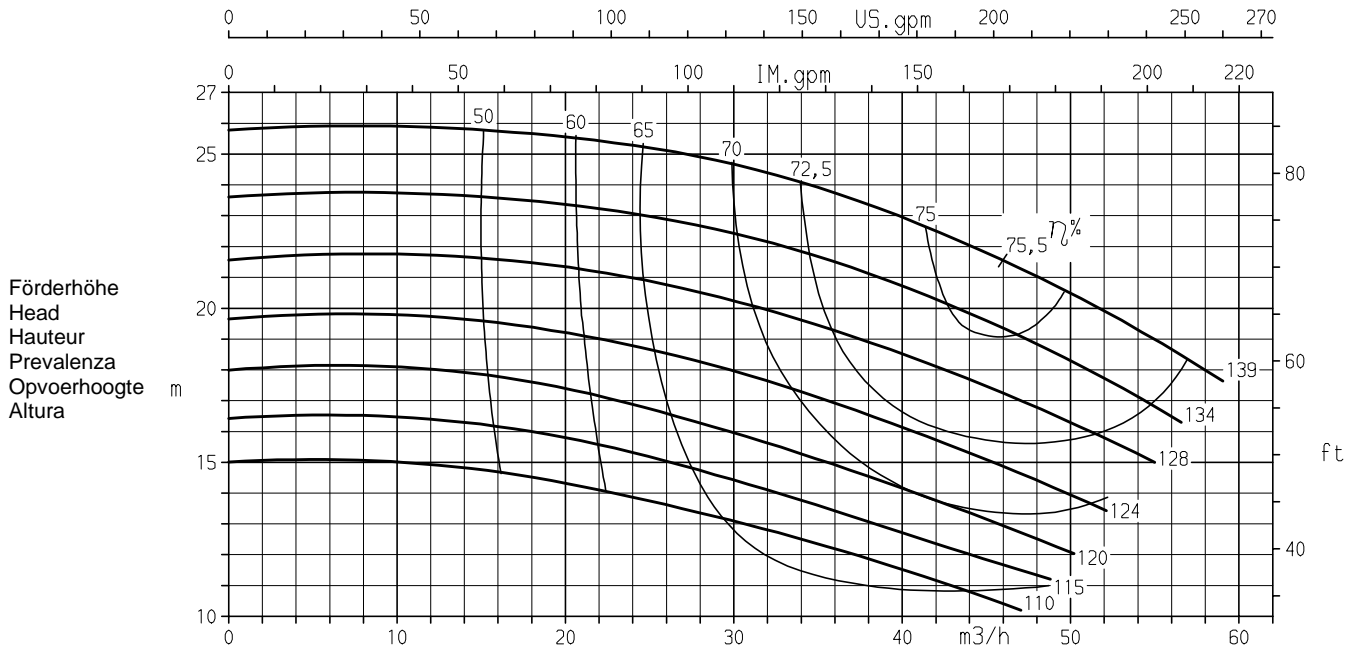

K2935.109

Förderstrom/Capacity/Débit/Portata/Kapaciteit/Caudal

Baureihe Pump type Modèle	Tipo Serie Tipo	Nennzahl Nom. speed Vitesse nom.	Velocità di rotazione nom. Nominaal toerental Revoluciones nom.	 KSB Aktiengesellschaft Pumpen Industrie- und Wassertechnik Postfach 13 60, D-91253 Pegnitz Bahnhofplatz 1, D-91257
Etaseco G, S	40-160	2900 1/min		
Angebots-Nr. Project No. No. de l'offre	Offerta-No. Offertenr. Oferta-No.	Pos.-Nr. Item No. No. de pos.	Pos.-Nr. Positiennr. Pos.-Nr.	

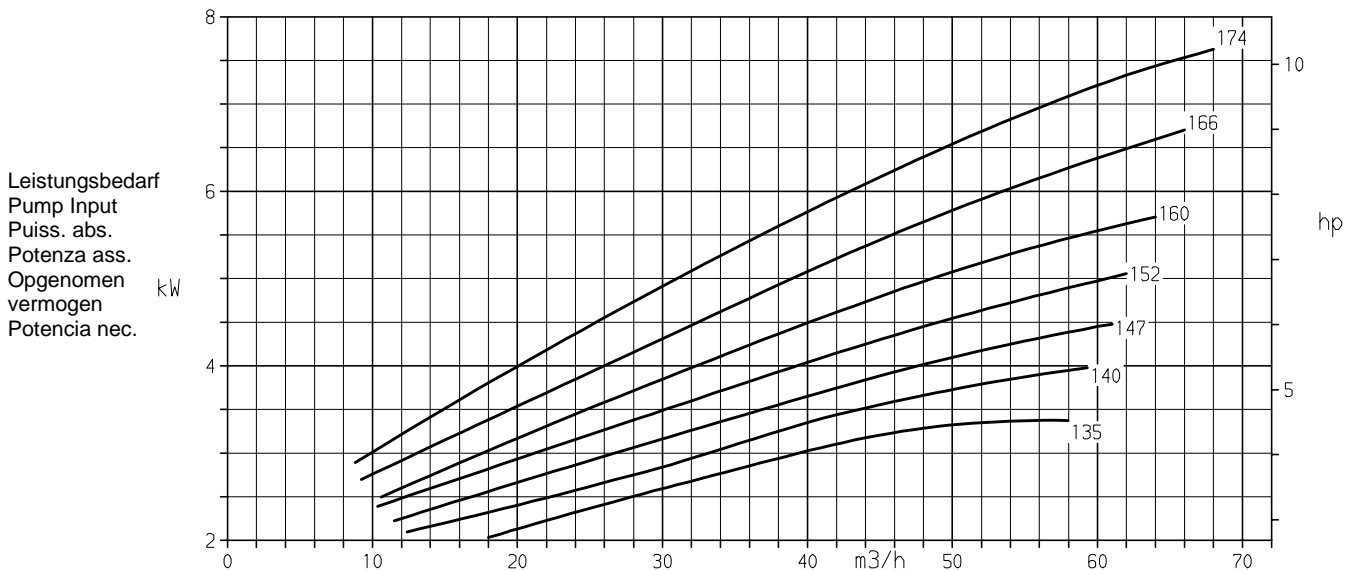
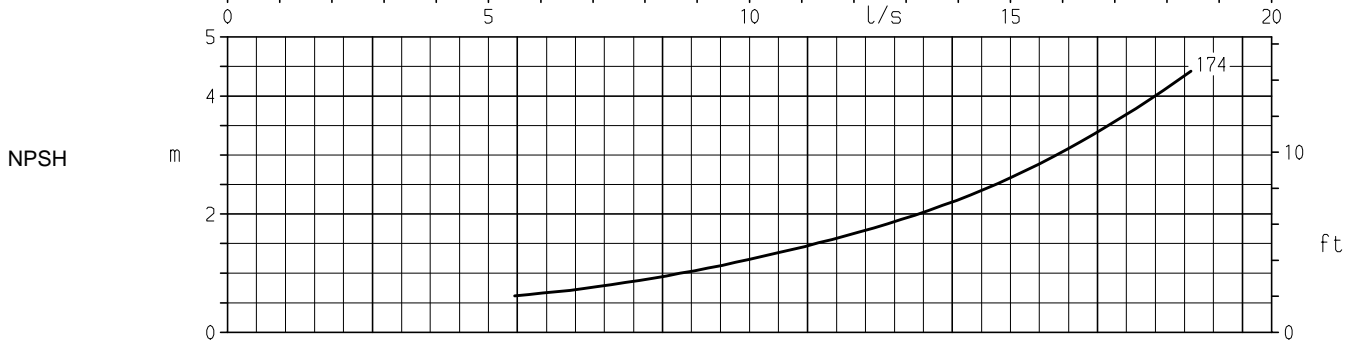
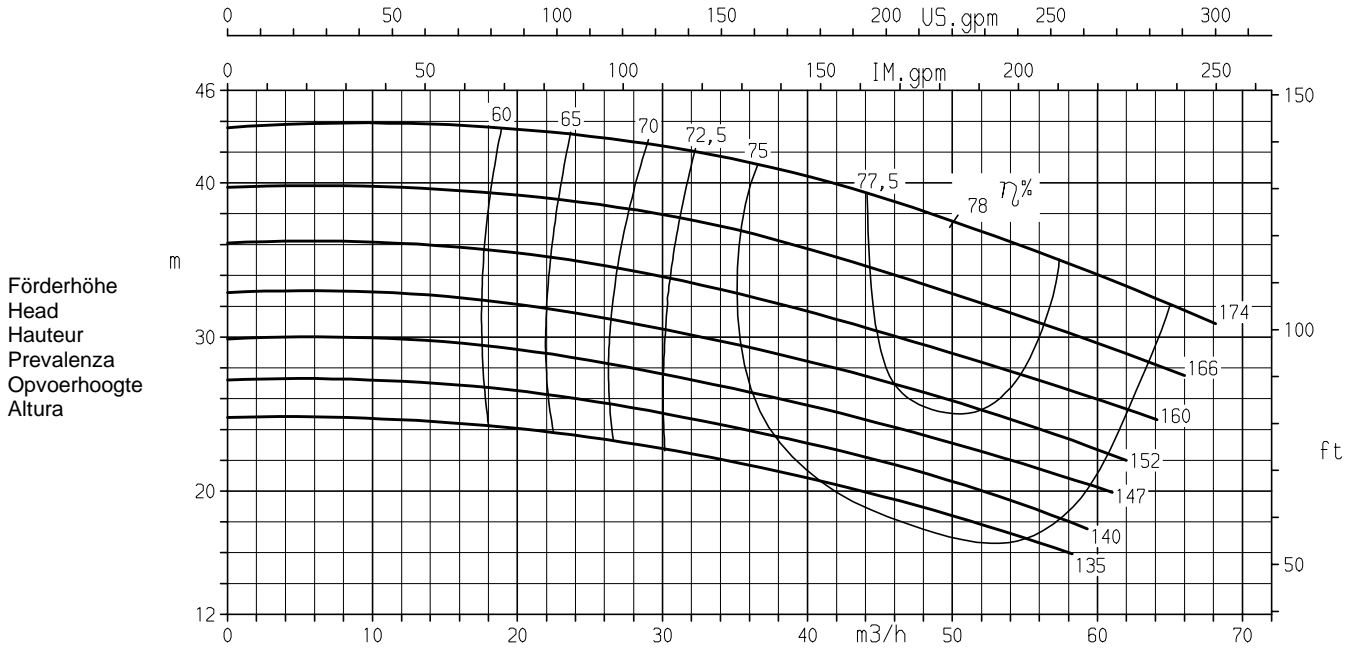

2935.110

Förderstrom/Capacity/Débit/Portata/Kapaciteit/Caudal

Baureihe Pump type Modèle	Tipo Serie Tipo	Nennndrehzahl Nom. speed Vitesse nom.	Velocità di rotazione nom. Nominaal toerental Revoluciones nom.	 KSB Aktiengesellschaft Pumpen Industrie- und Wassertechnik Postfach 13 60, D-91253 Pegnitz Bahnhofplatz 1, D-91257
Etaseco G, S	40-200	2900 1/min		
Angebots-Nr. Project No. No. de l'offre	Offerta-No. Offertenr. Oferta-No.	Pos.-Nr. Item No. No. de pos.	Pos.-Nr. Positiennr. Pos.-Nr.	

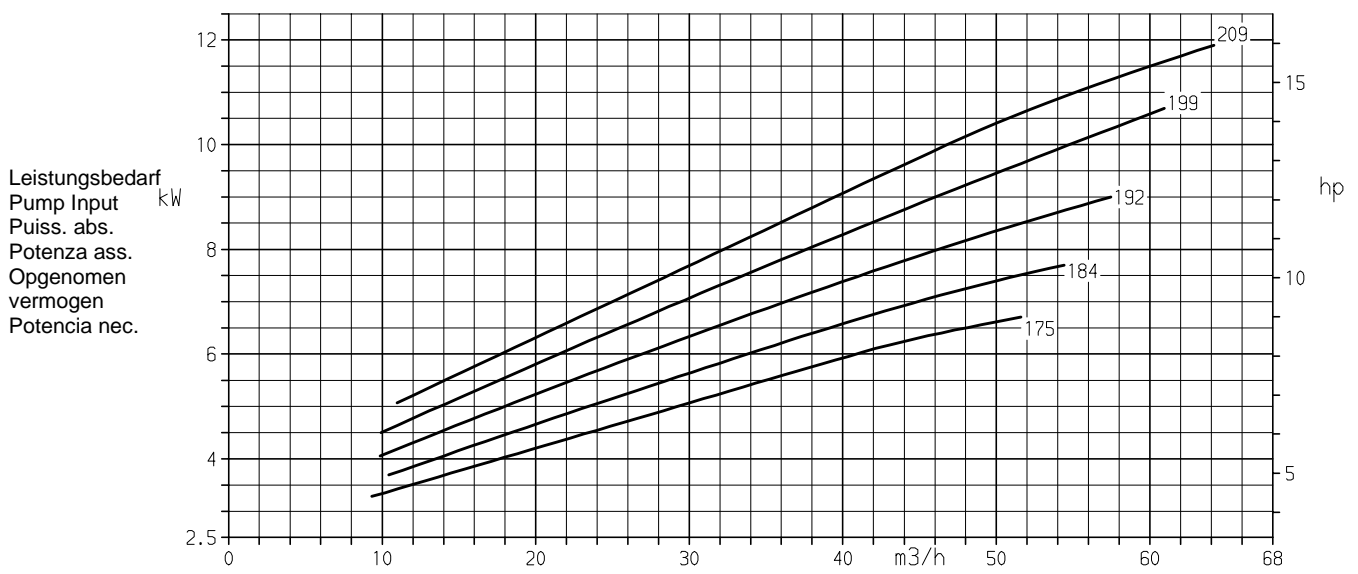
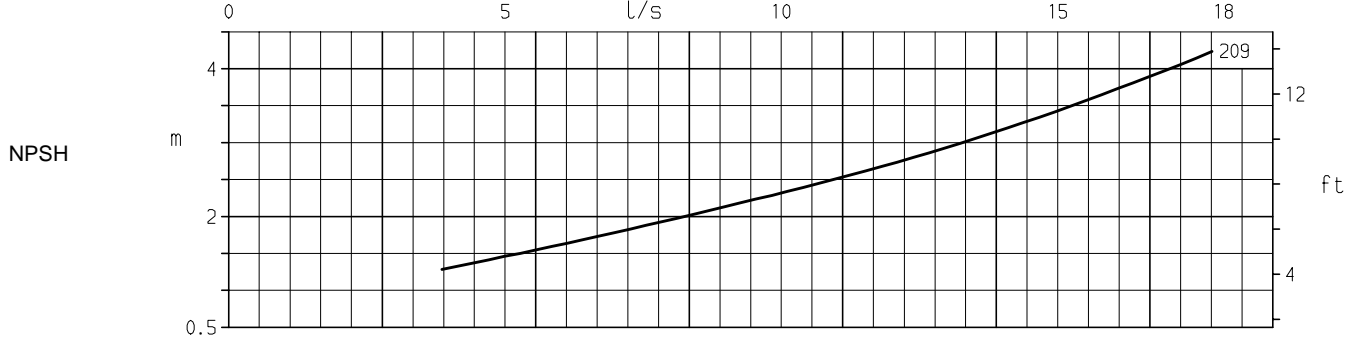
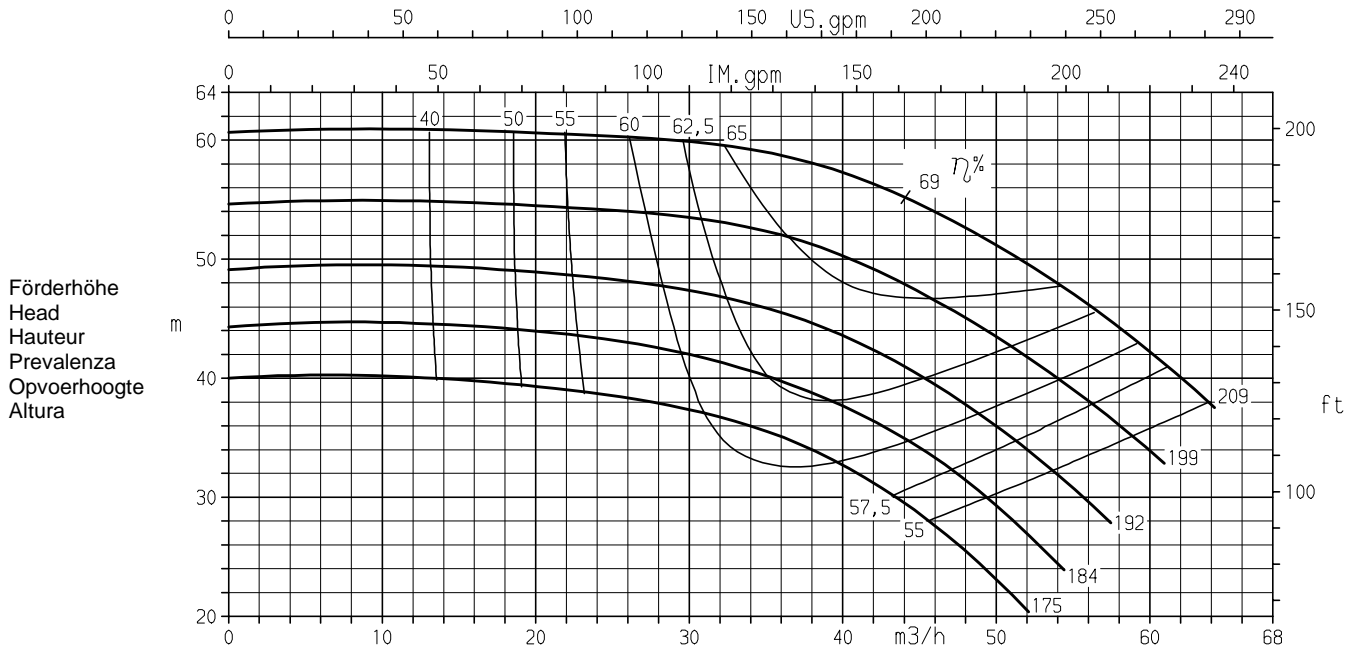

K2935.111

Förderstrom/Capacity/Débit/Portata/Kapaciteit/Caudal

Baureihe Pump type Modèle	Tipo Serie Tipo	Nennzahl Nom. speed Vitesse nom.	Velocità di rotazione nom. Nominaal toerental Revoluciones nom.	 KSB Aktiengesellschaft Pumpen Industrie- und Wassertechnik Postfach 13 60, D-91253 Pegnitz Bahnhofplatz 1, D-91257
Etaseco G, S	40-250	2900 1/min		
Angebots-Nr. Project No. No. de l'offre	Offerta-No. Offertenr. Oferta-No.	Pos.-Nr. Item No. No. de pos.	Pos.-Nr. Positiennr. Pos.-Nr.	

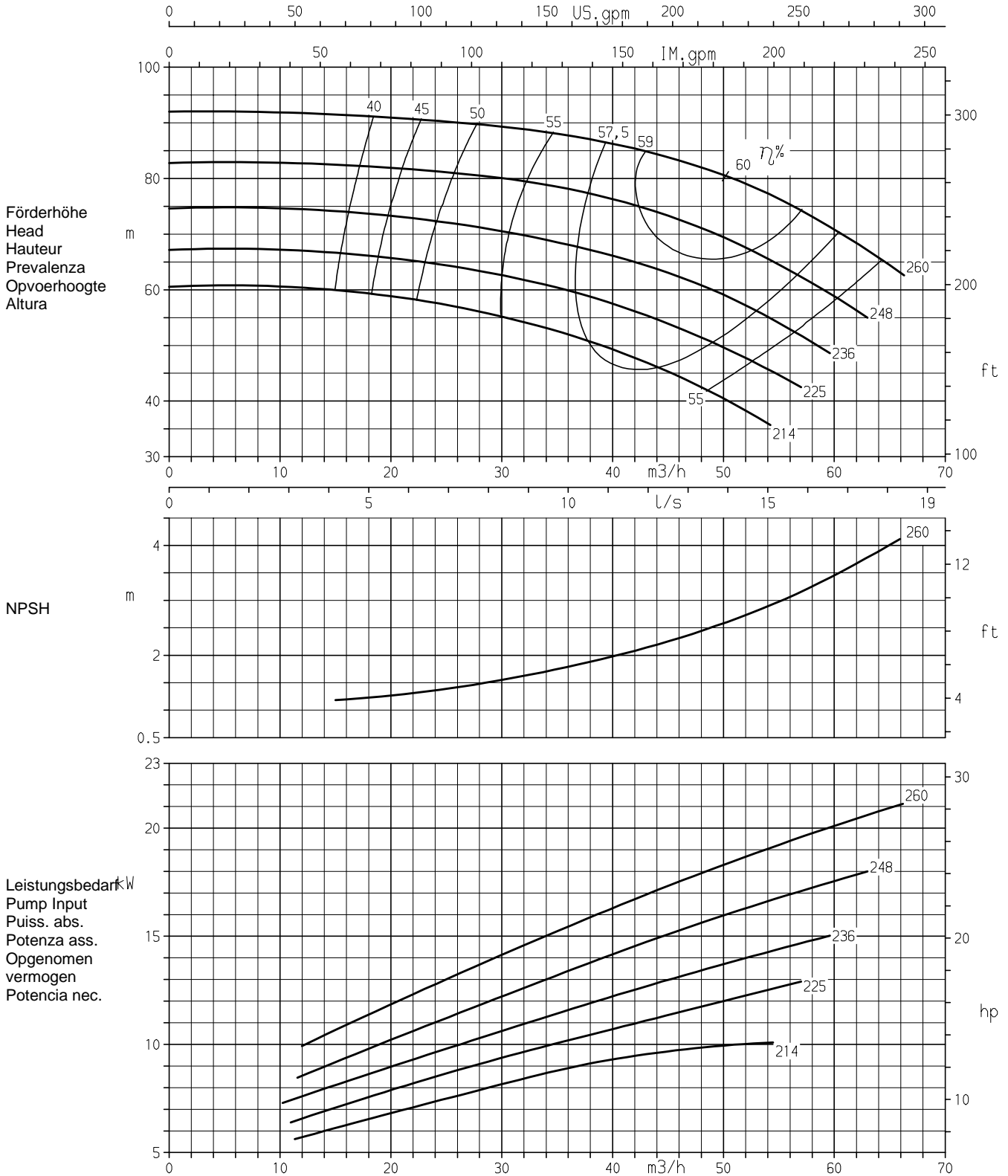

K2935.112

Förderstrom/Capacity/Débit/Portata/Kapaciteit/Caudal

Baureihe Pump type Modèle	Tipo Serie Tipo	Nenn Drehzahl Nom. speed Vitesse nom.	Velocità di rotazione nom. Nominaal toerental Revoluciones nom.	 KSB KSB Aktiengesellschaft Pumpen Industrie- und Wassertechnik Postfach 13 60, D-91253 Pegnitz Bahnhofplatz 1, D-91257
Etaseco G	50-125	2900 1/min		
Angebots-Nr. Project No. No. de l'offre	Offerta-No. Offertenr. Oferta-No.	Pos.-Nr. Item No. No. de pos.	Pos.-Nr. Positiennr. Pos.-Nr.	

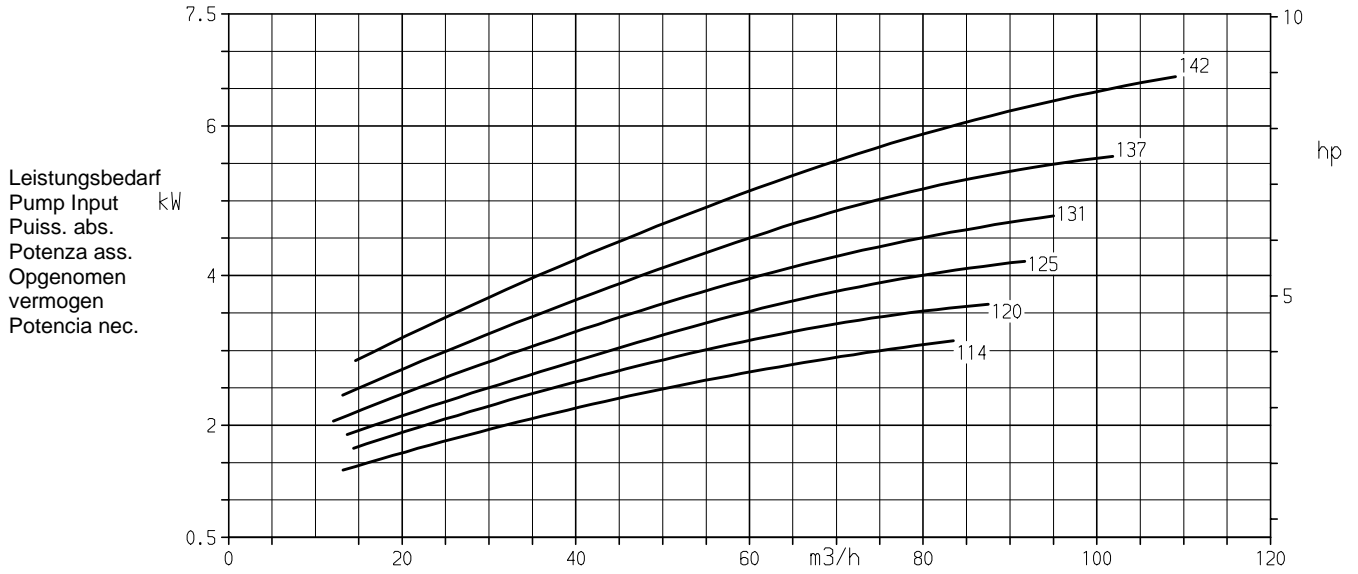
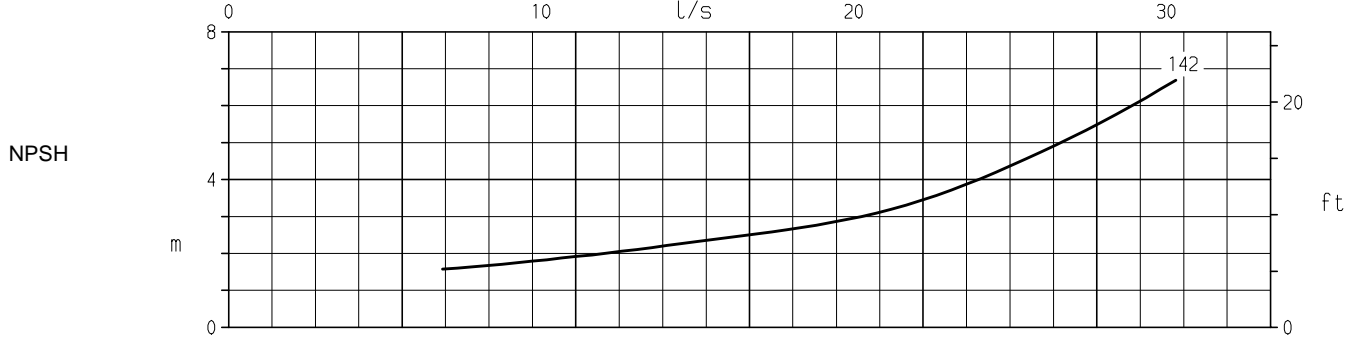
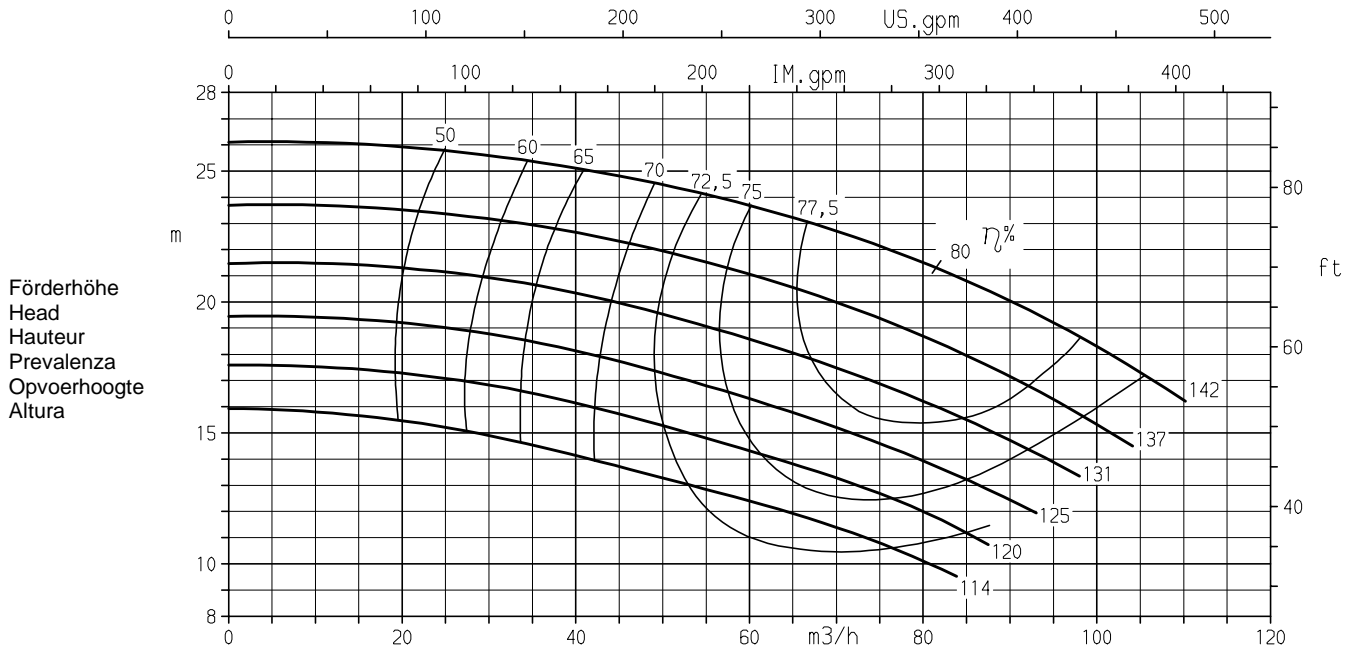

K2935.113

Förderstrom/Capacity/Débit/Portata/Kapazität/Caudal

Baureihe Pump type Modèle	Tipo Serie Tipo	Nenndrehzahl Nom. speed Vitesse nom.	Velocità di rotazione nom. Nominaal toerental Revoluciones nom.	 KSB Aktiengesellschaft Pumpen Industrie- und Wassertechnik Postfach 13 60, D-91253 Pegnitz Bahnhofplatz 1, D-91257
Etaseco G, S	50-160	2900 1/min		
Angebots-Nr. Project No. No. de l'offre	Offerta-No. Offertenr. Oferta-No.	Pos.-Nr. Item No. No. de pos.	Pos.-Nr. Positiönr. Pos.-Nr.	

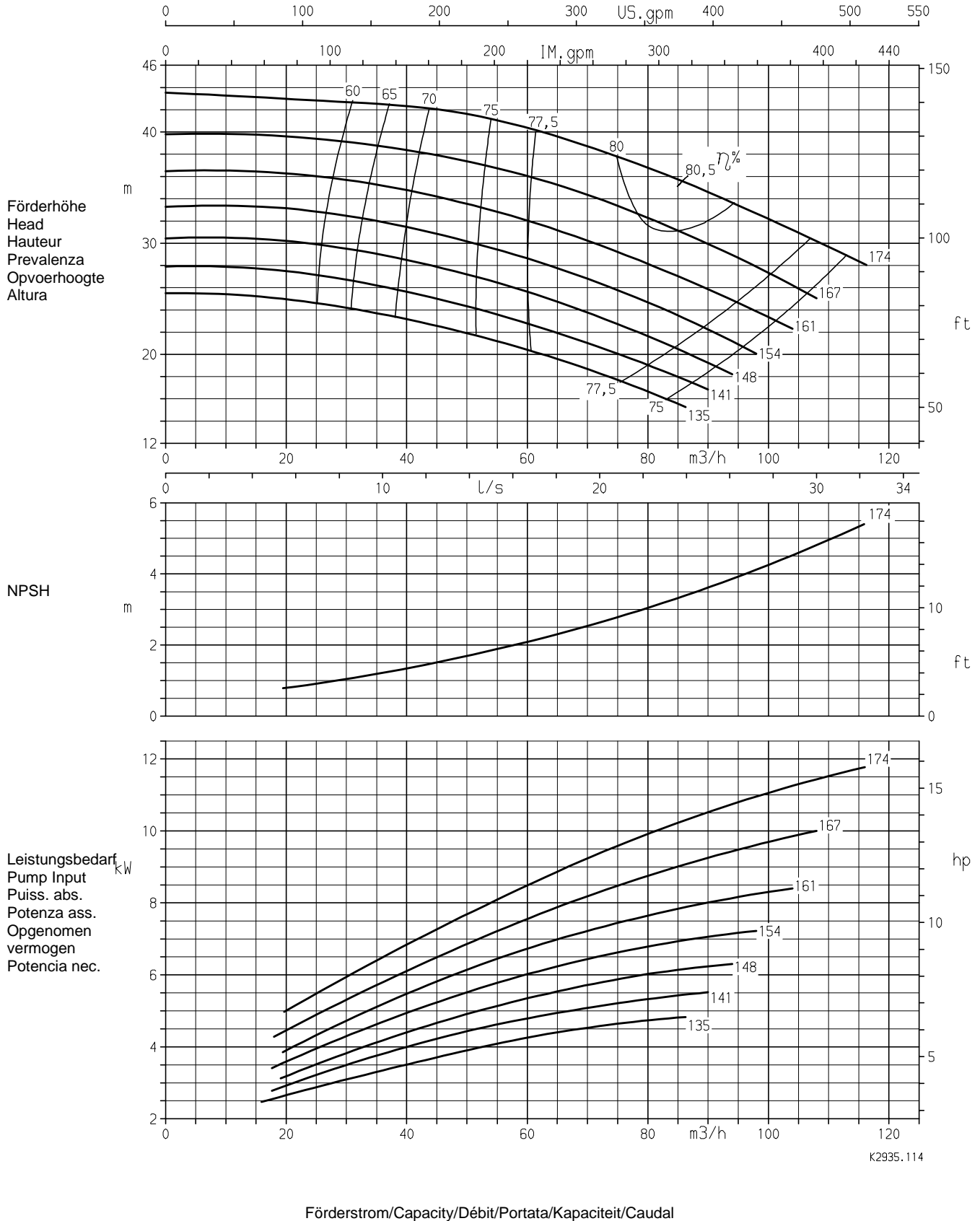

K2935.114

Baureihe Pump type Modèle	Tipo Serie Tipo	Nennndrehzahl Nom. speed Vitesse nom.	Velocità di rotazione nom. Nominaal toerental Revoluciones nom.	 KSB KSB Aktiengesellschaft Pumpen Industrie- und Wassertechnik Postfach 13 60, D-91253 Pegnitz Bahnhofplatz 1, D-91257
Etaseco G, S	50-200	2900 1/min		
Angebots-Nr. Project No. No. de l'offre	Offerta-No. Offertenr. Oferta-No.	Pos.-Nr. Item No. No. de pos.	Pos.-Nr. Positiennr. Pos.-Nr.	

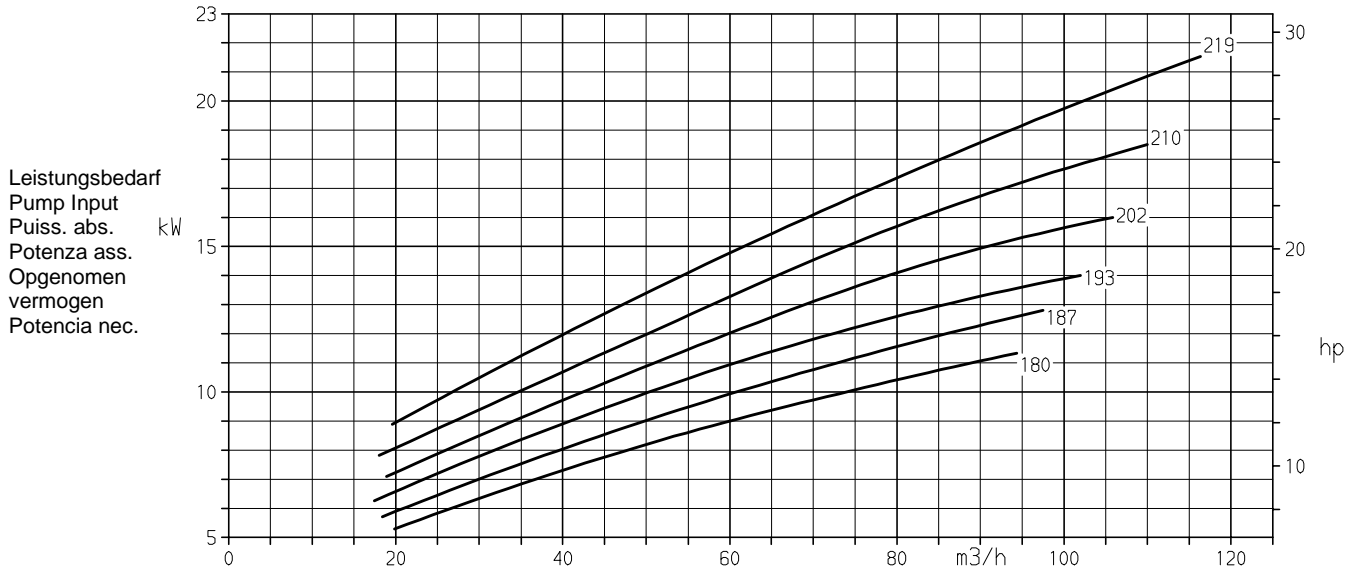
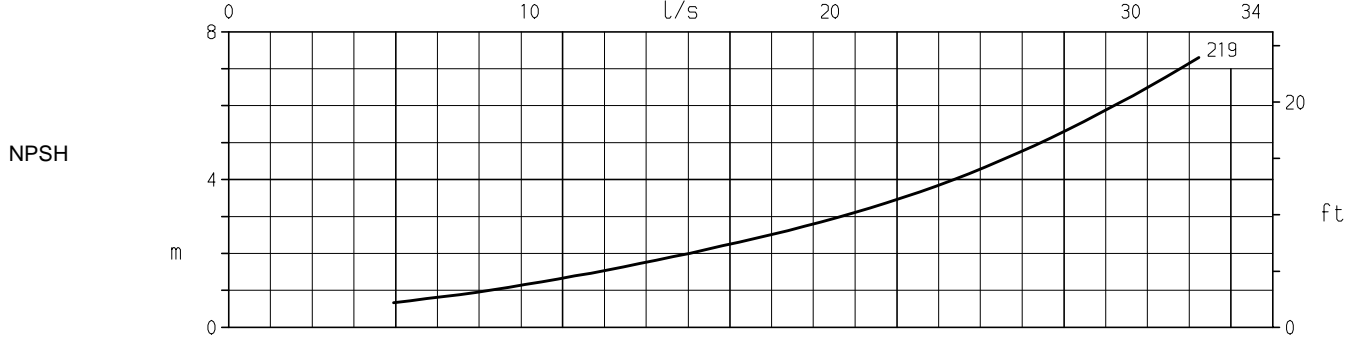
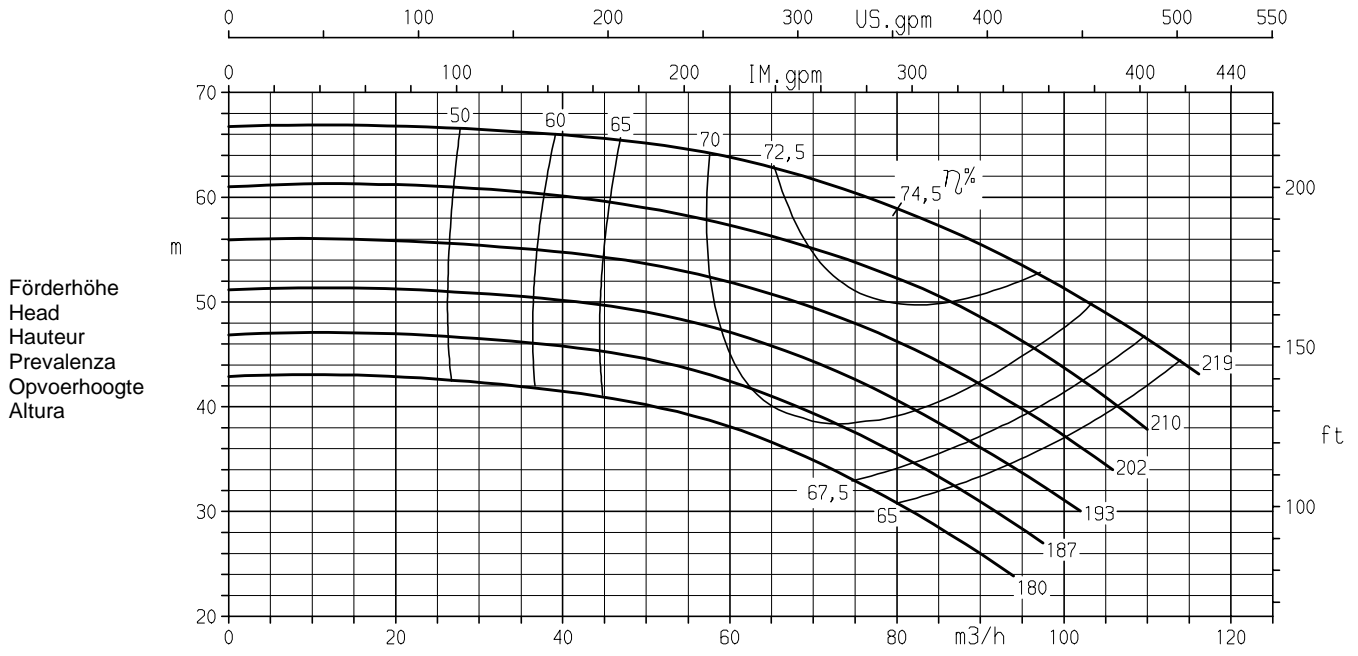

K2935.115

Förderstrom/Capacity/Débit/Portata/Kapaciteit/Caudal

Baureihe Pump type Modèle	Tipo Serie Tipo	Nennzahl Nom. speed Vitesse nom.	Velocità di rotazione nom. Nominaal toerental Revoluciones nom.	 KSB Aktiengesellschaft Pumpen Industrie- und Wassertechnik Postfach 13 60, D-91253 Pegnitz Bahnhofplatz 1, D-91257
Etaseco G	65-125	2900 1/min		
Angebots-Nr. Project No. No. de l'offre	Offerta-No. Offertenr. Oferta-No.	Pos.-Nr. Item No. No. de pos.	Pos.-Nr. Positiennr. Pos.-Nr.	

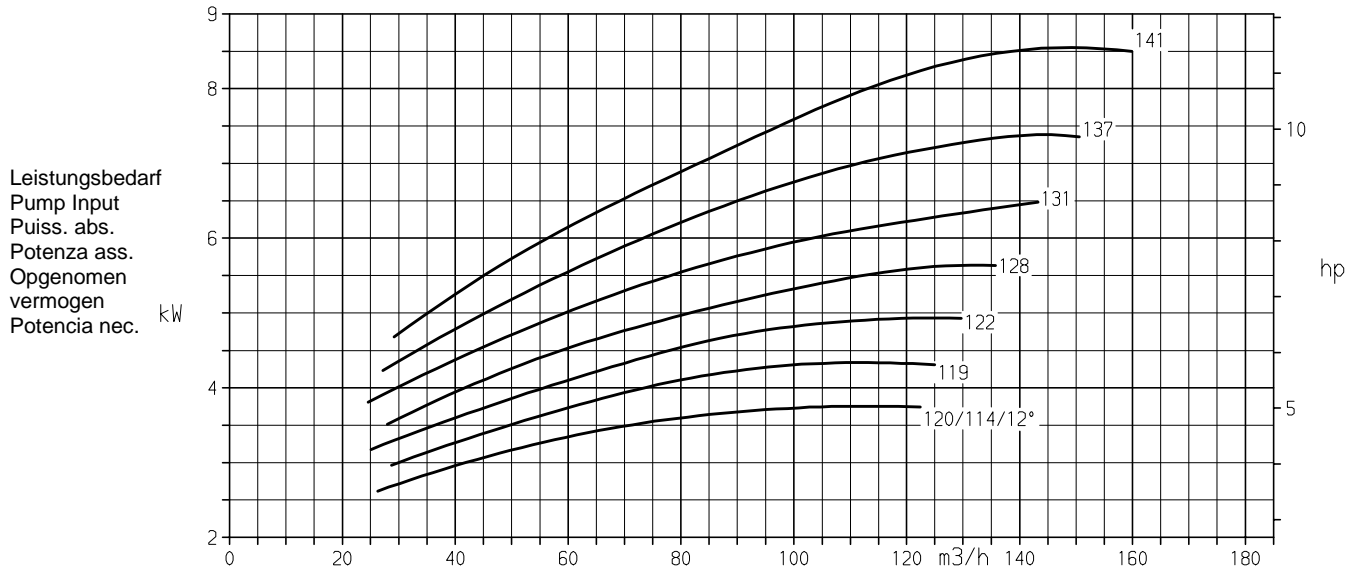
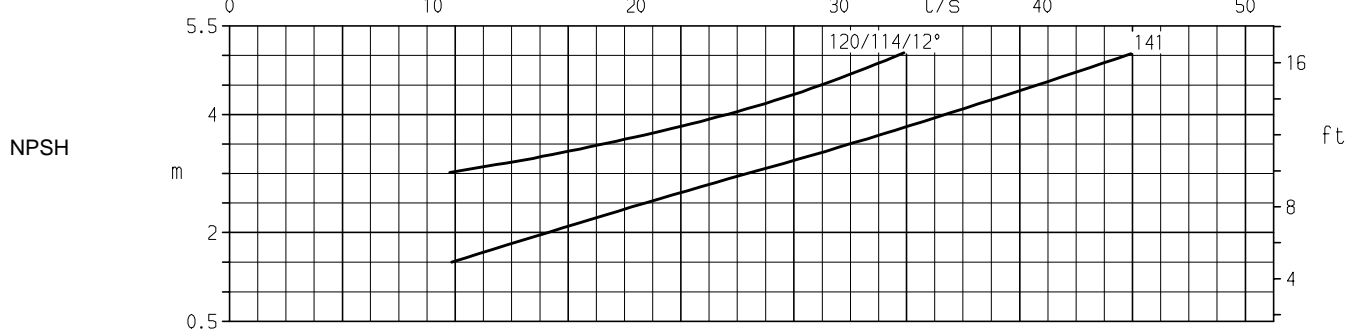
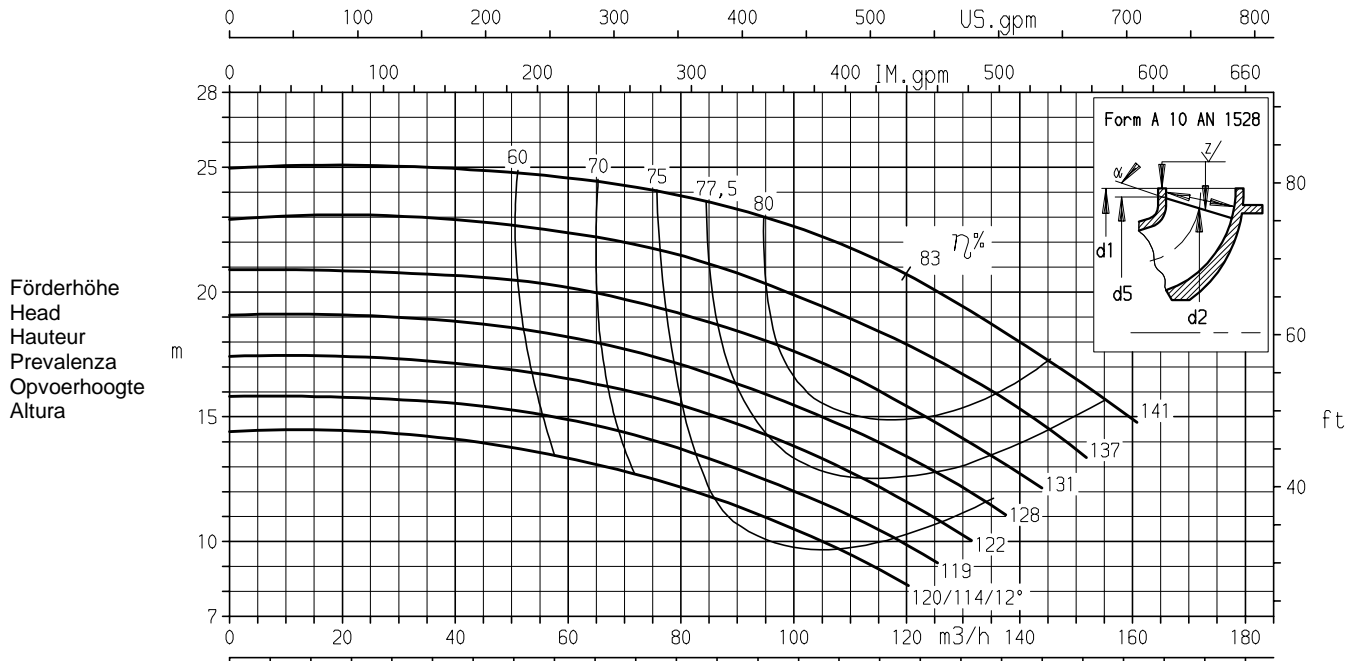

K2935.116/2

Förderstrom/Capacity/Débit/Portata/Kapaciteit/Caudal

Baureihe Pump type Modèle	Tipo Serie Tipo	Nennndrehzahl Nom. speed Vitesse nom.	Velocità di rotazione nom. Nominaal toerental Revoluciones nom.	 KSB KSB Aktiengesellschaft Pumpen Industrie- und Wassertechnik Postfach 13 60, D-91253 Pegnitz Bahnhofplatz 1, D-91257
Etaseco G, S	65-160	2900 1/min		
Angebots-Nr. Project No. No. de l'offre	Offerta-No. Offertenr. Oferta-No.	Pos.-Nr. Item No. No. de pos.	Pos.-Nr. Positiennr. Pos.-Nr.	

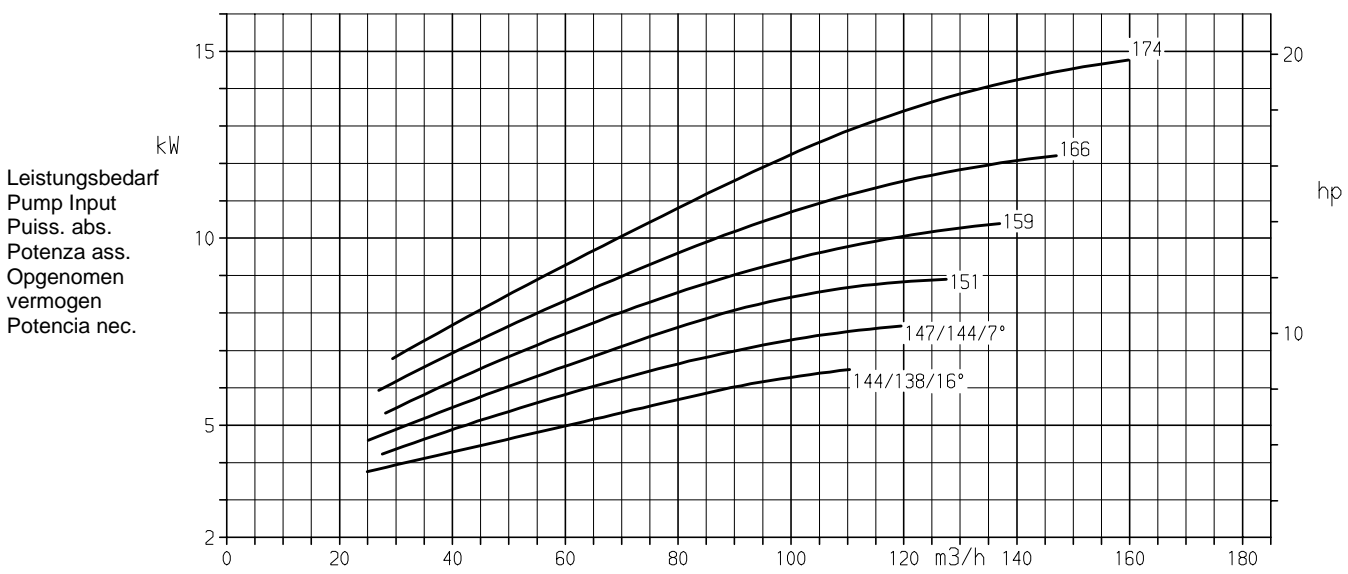
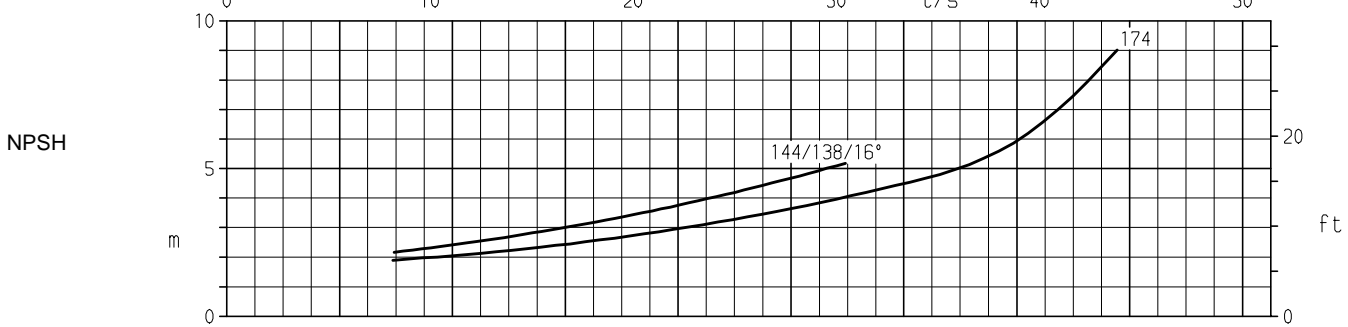
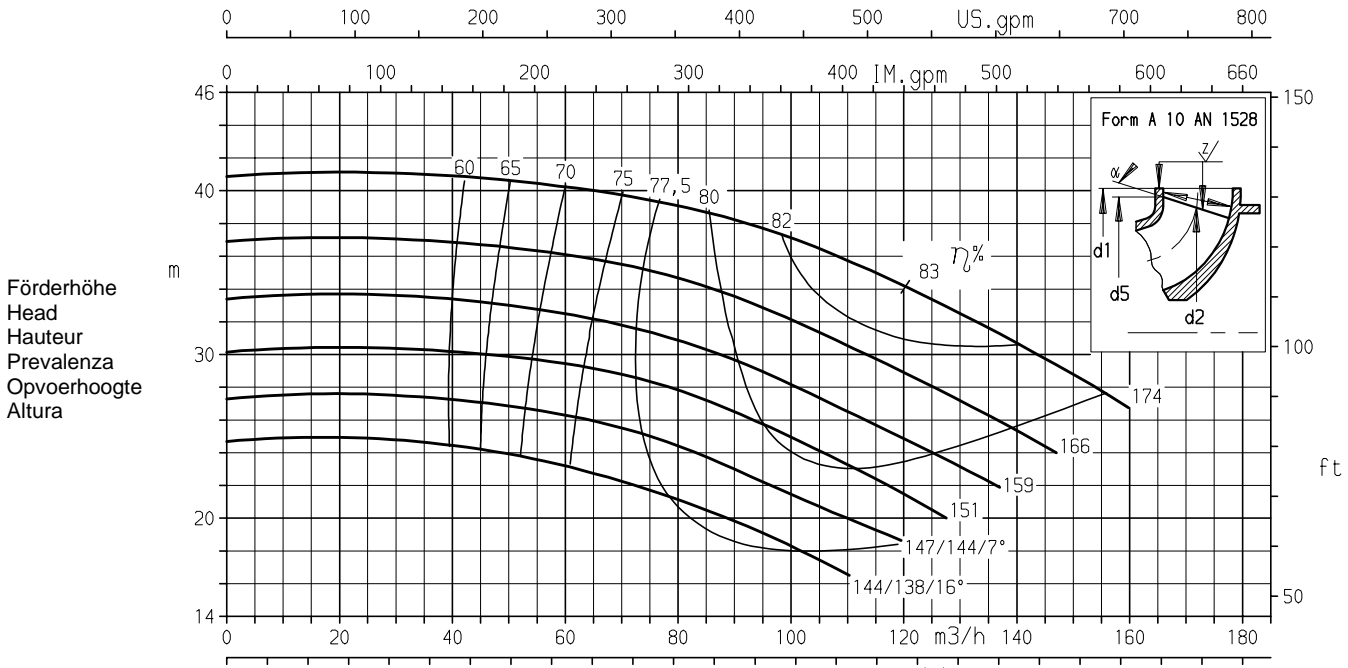

K2935.117/2

Förderstrom/Capacity/Débit/Portata/Kapaciteit/Caudal

Baureihe Pump type Modèle	Tipo Serie Tipo	Nennndrehzahl Nom. speed Vitesse nom.	Velocità di rotazione nom. Nominaal toerental Revoluciones nom.	 KSB KSB Aktiengesellschaft Pumpen Industrie- und Wassertechnik Postfach 13 60, D-91253 Pegnitz Bahnhofplatz 1, D-91257
Etaseco G, S	65-200	2900 1/min		
Angebots-Nr. Project No. No. de l'offre	Offerta-No. Offertenr. Oferta-No.	Pos.-Nr. Item No. No. de pos.	Pos.-Nr. Positiennr. Pos.-Nr.	

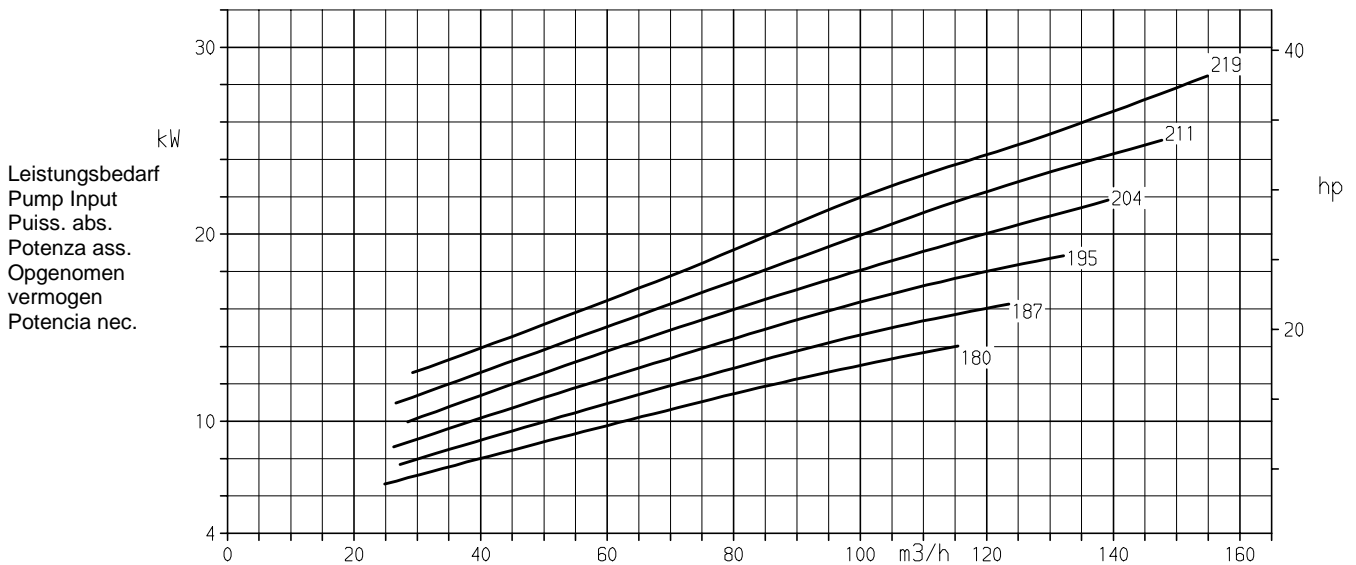
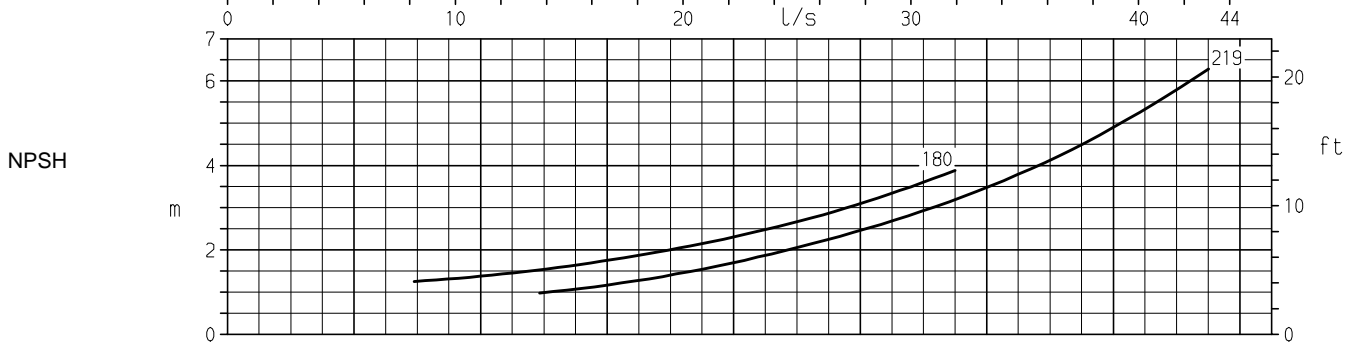
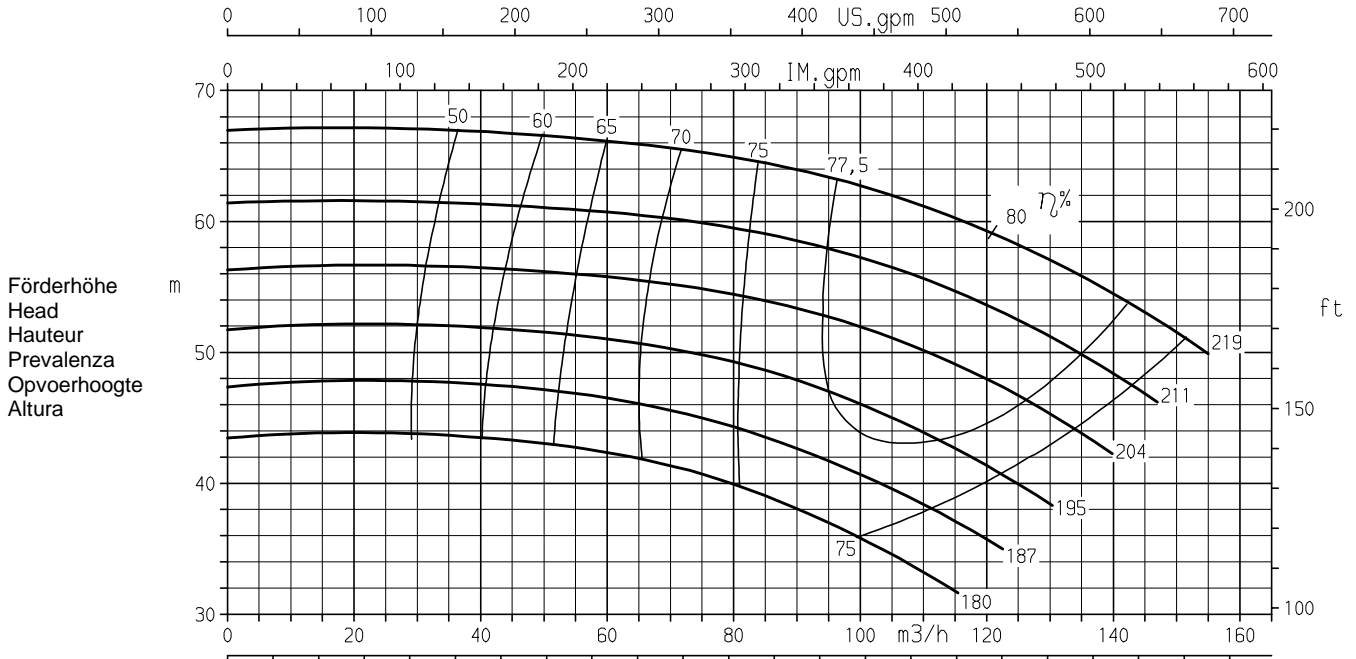

K2935.118

Förderstrom/Capacity/Débit/Portata/Kapaciteit/Caudal

Baureihe Pump type Modèle	Tipo Serie Tipo	Nenn Drehzahl Nom. speed Vitesse nom.	Velocità di rotazione nom. Nominaal toerental Revoluciones nom.	 KSB KSB Aktiengesellschaft Pumpen Industrie- und Wassertechnik Postfach 13 60, D-91253 Pegnitz Bahnhofplatz 1, D-91257
Etaseco G, S	80-160	2900 1/min		
Angebots-Nr. Project No. No. de l'offre	Offerta-No. Offertenr. Oferta-No.	Pos.-Nr. Item No. No. de pos.	Pos.-Nr. Positiönr. Pos.-Nr.	

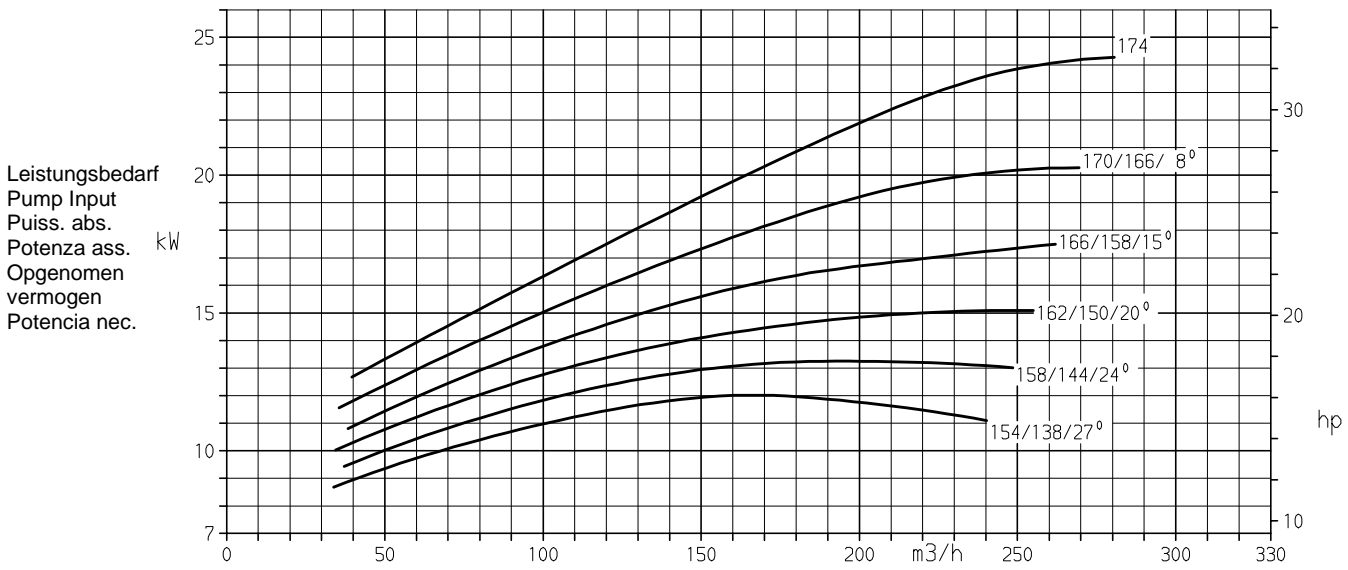
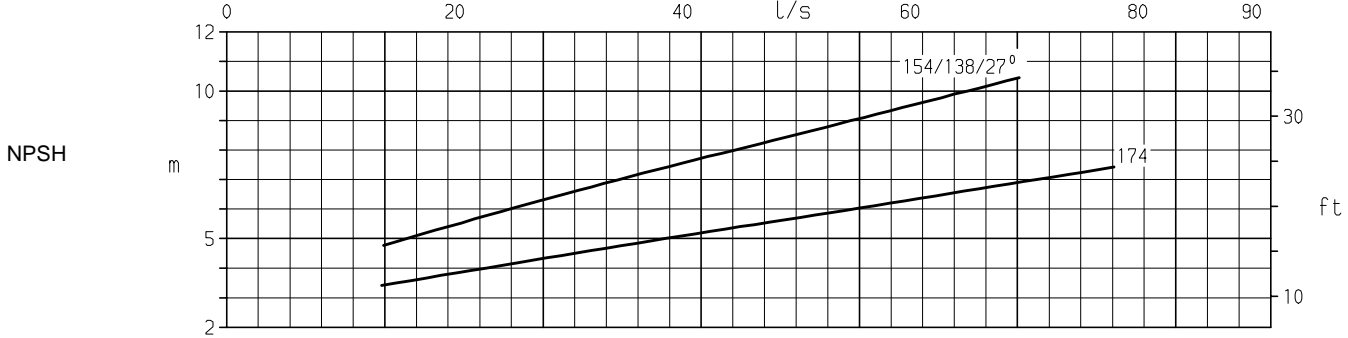
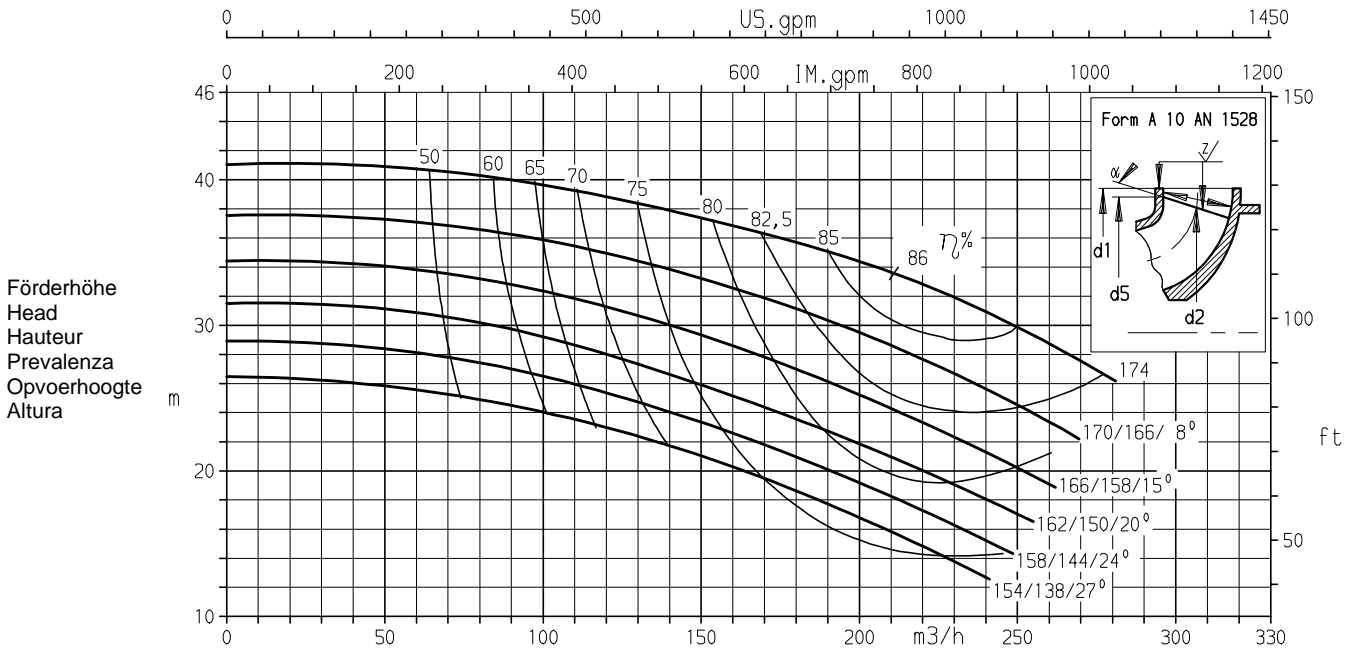

K2935.119/2

Förderstrom/Capacity/Débit/Portata/Kapaciteit/Caudal

Baureihe Pump type Modèle	Tipo Serie Tipo	Nenndrehzahl Nom. speed Vitesse nom.	Velocità di rotazione nom. Nominaal toerental Revoluciones nom.	 KSB Aktiengesellschaft Pumpen Industrie- und Wassertechnik Postfach 13 60, D-91253 Pegnitz Bahnhofplatz 1, D-91257
Etaseco G-I	32-160	2900 1/min		
Angebots-Nr. Project No. No. de l'offre	Offerta-No. Offertenr. Oferta-No.	Pos.-Nr. Item No. No. de pos.	Pos.-Nr. Positiennr. Pos.-Nr.	

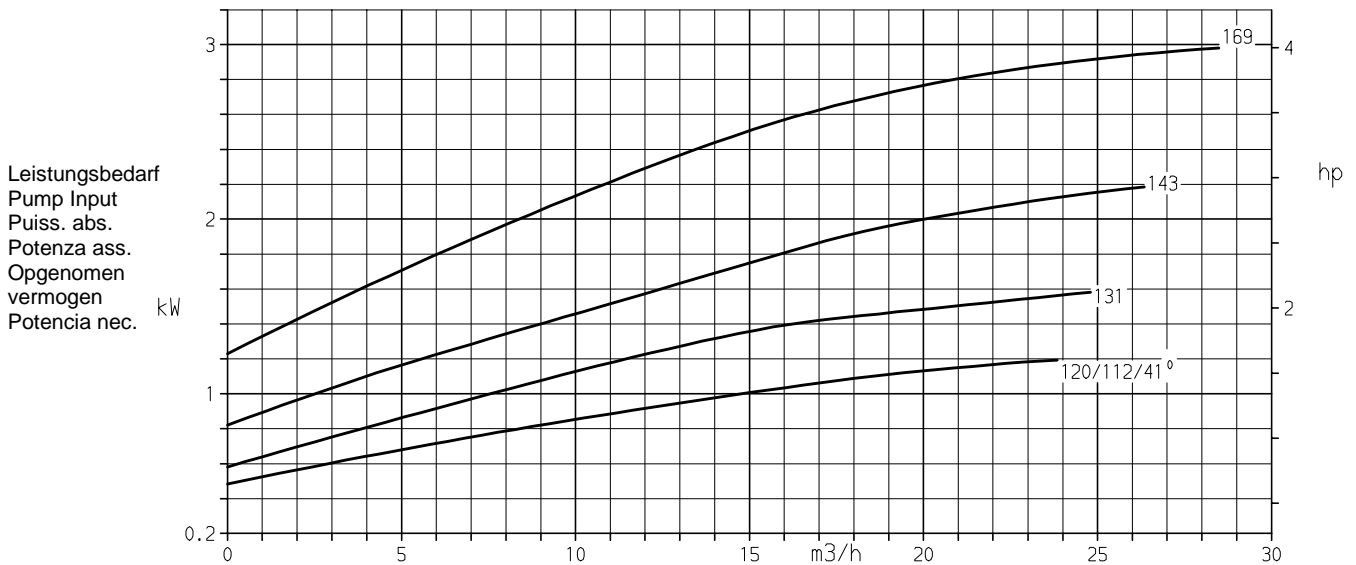
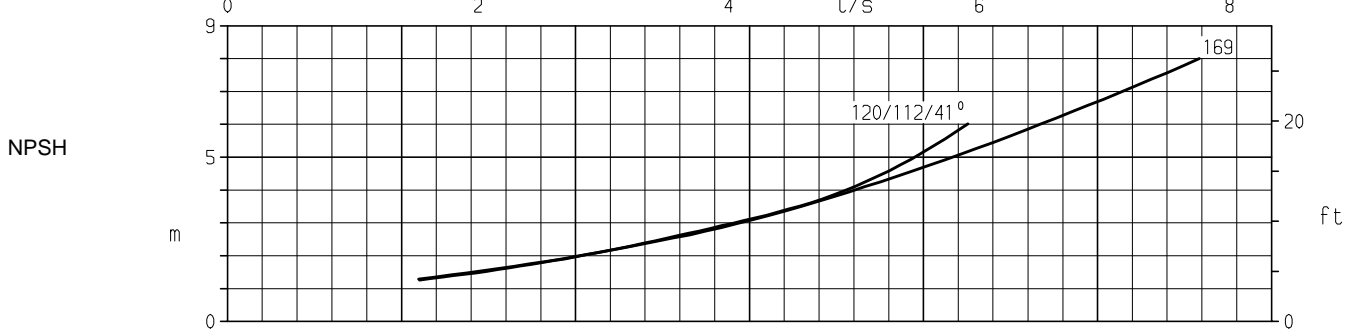
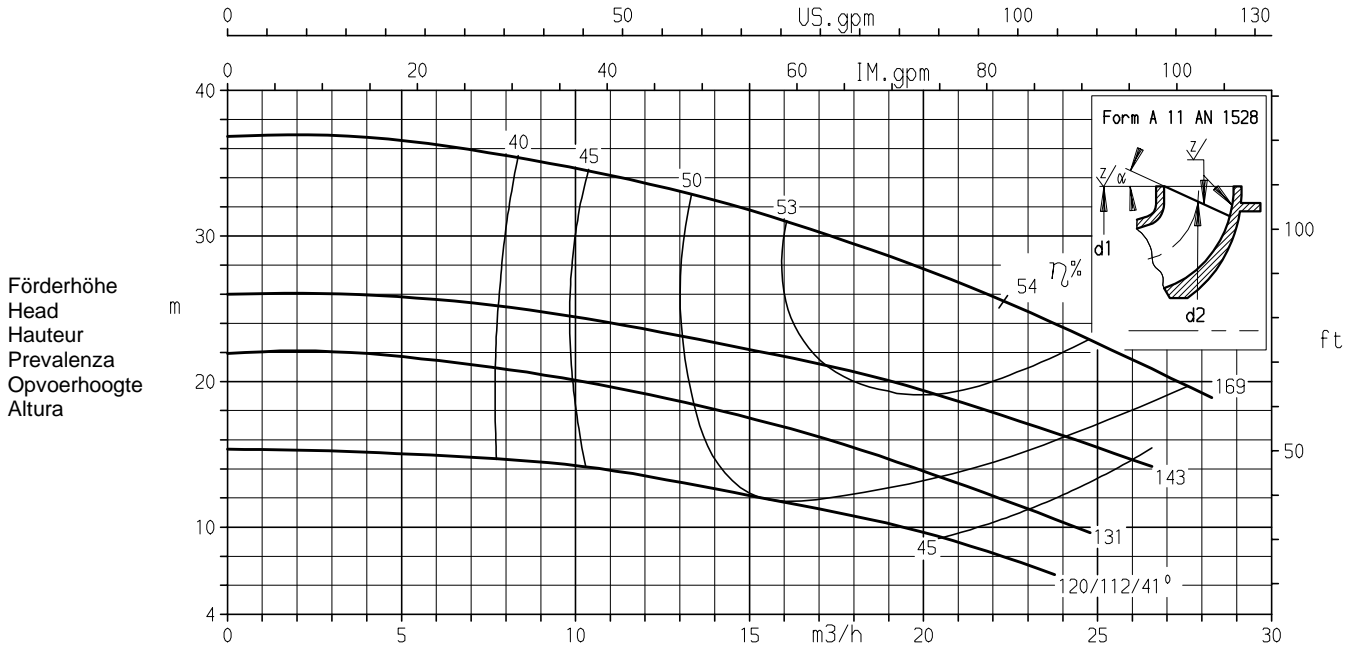

K2935.201/2

Förderstrom/Capacity/Débit/Portata/Kapaciteit/Caudal

Baureihe Pump type Modèle	Tipo Serie Tipo	Nenn Drehzahl Nom. speed Vitesse nom.	Velocità di rotazione nom. Nominaal toerental Revoluciones nom.	 KSB KSB Aktiengesellschaft Pumpen Industrie- und Wassertechnik Postfach 13 60, D-91253 Pegnitz Bahnhofplatz 1, D-91257
Etaseco G-I	32-200	2900 1/min		
Angebots-Nr. Project No. No. de l'offre	Offerta-No. Offertenr. Oferta-No.	Pos.-Nr. Item No. No. de pos.	Pos.-Nr. Positiën. Pos.-Nr.	

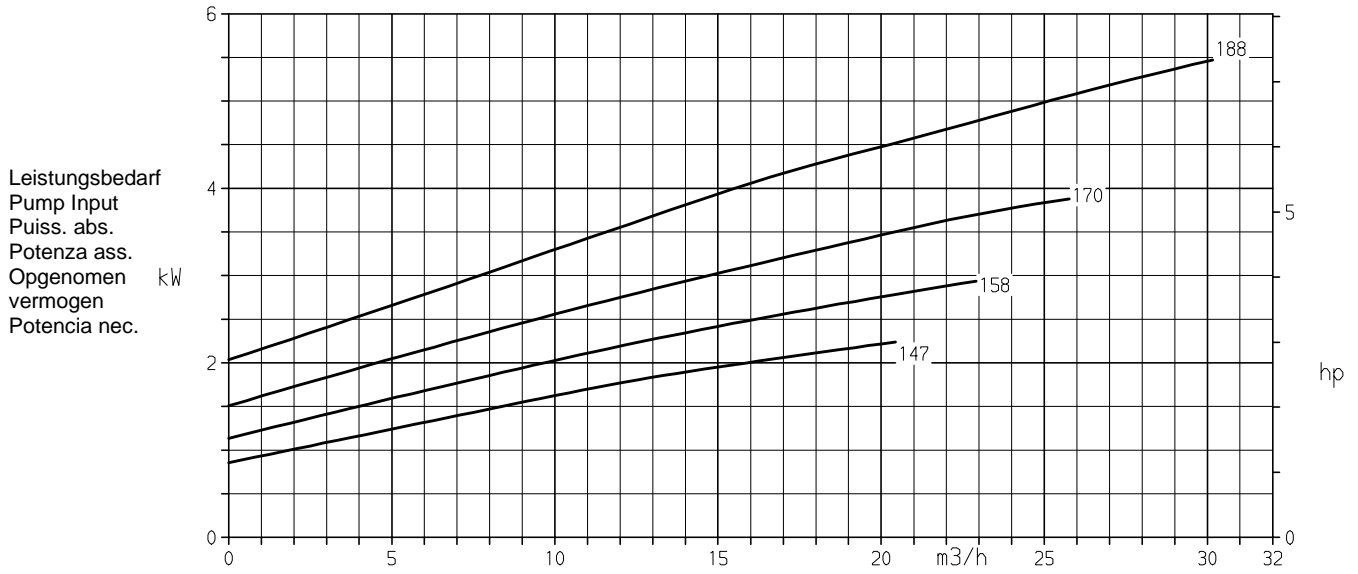
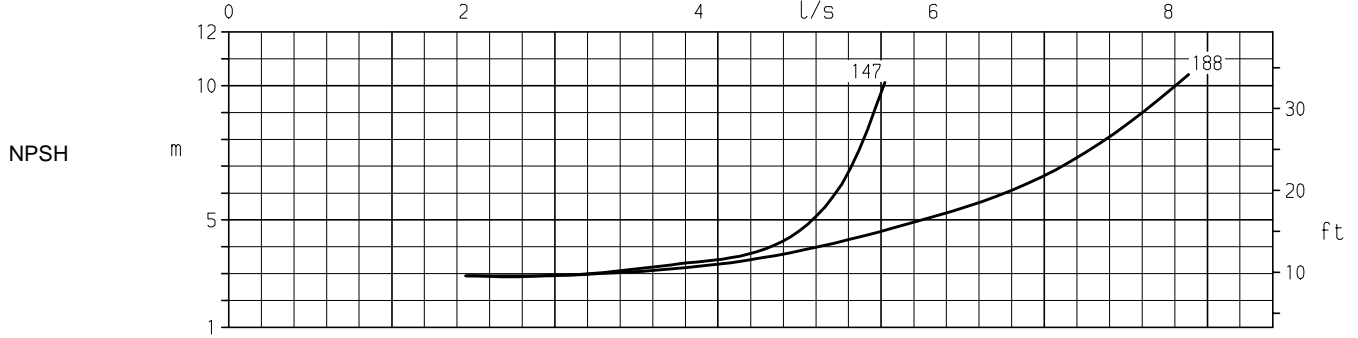
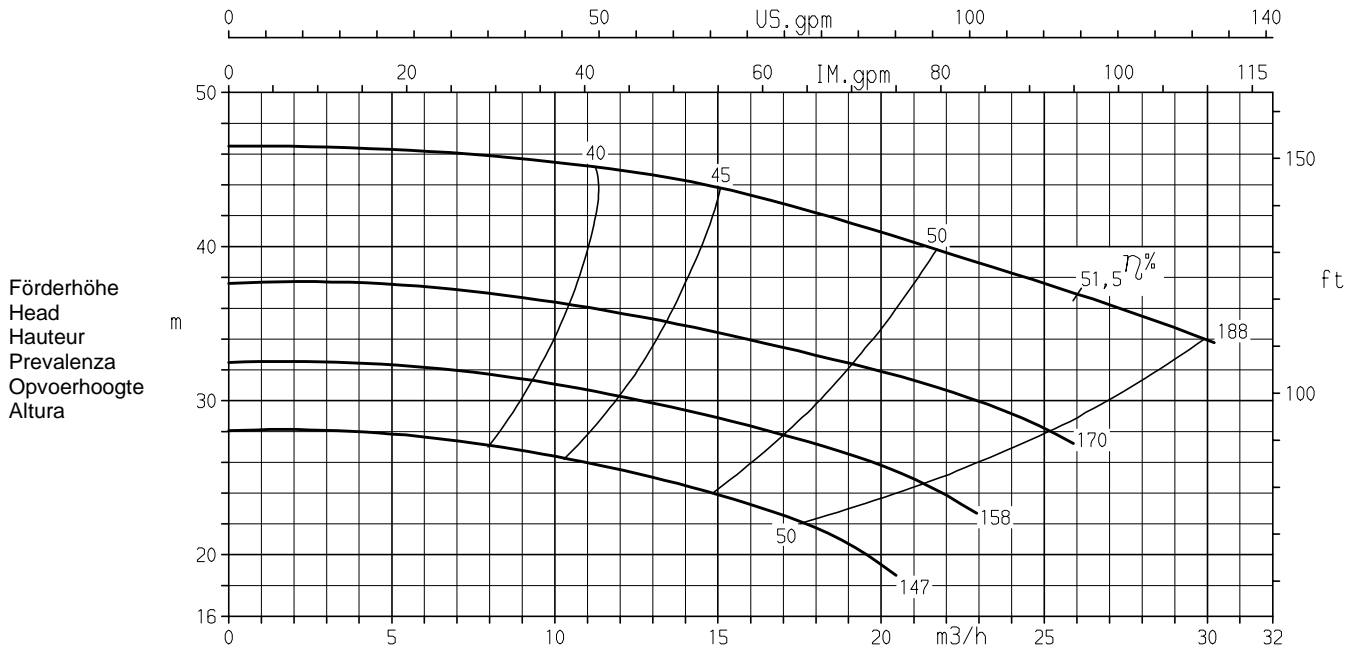

K2935.202

Förderstrom/Capacity/Débit/Portata/Kapaciteit/Caudal

Baureihe Pump type Modèle	Tipo Serie Tipo	Nenndrehzahl Nom. speed Vitesse nom.	Velocità di rotazione nom. Nominaal toerental Revoluciones nom.	 KSB Aktiengesellschaft Pumpen Industrie- und Wassertechnik Postfach 13 60, D-91253 Pegnitz Bahnhofplatz 1, D-91257
Etaseco G-I	40-160	2900 1/min		
Angebots-Nr. Project No. No. de l'offre	Offerta-No. Offertenr. Oferta-No.	Pos.-Nr. Item No. No. de pos.	Pos.-Nr. Positiennr. Pos.-Nr.	

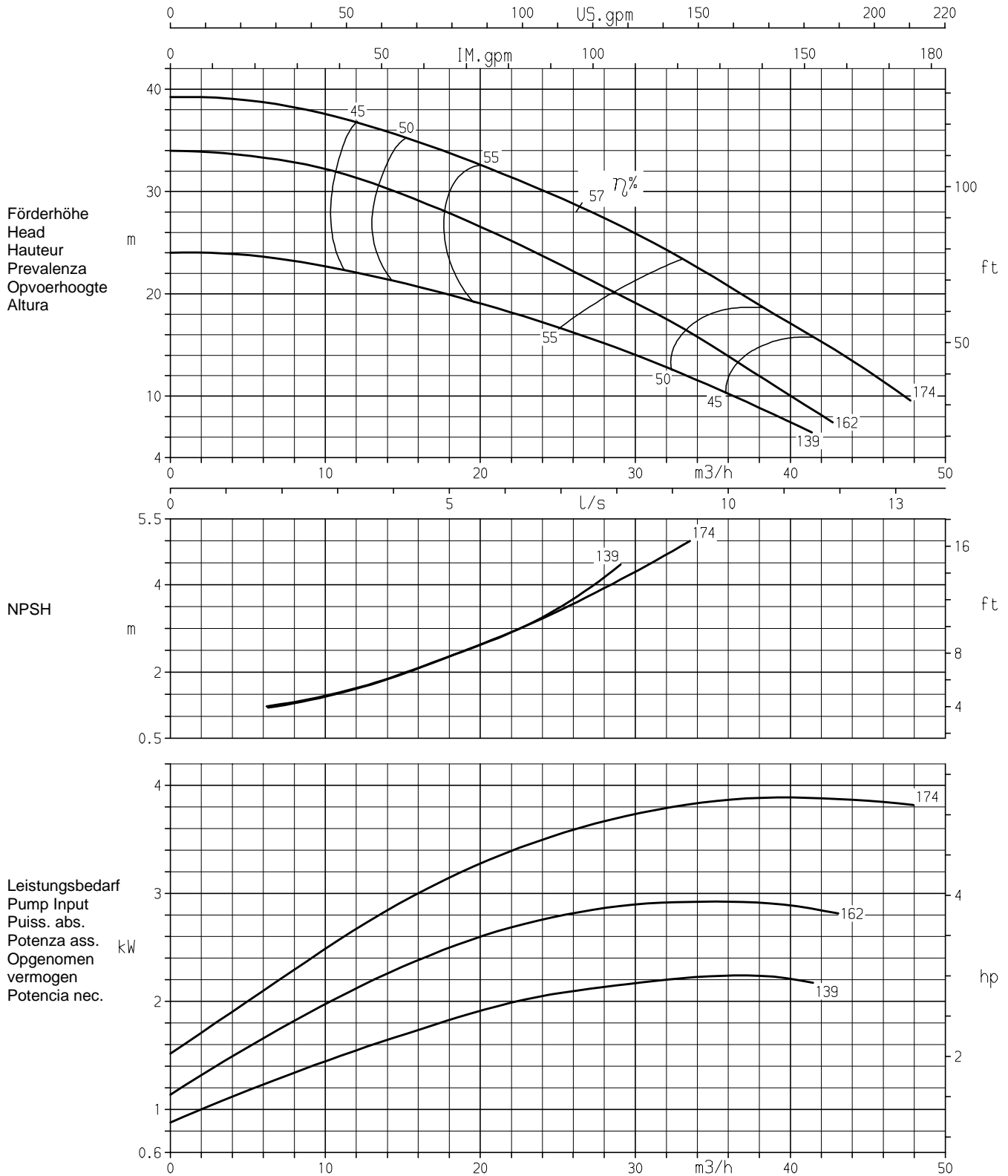

K2935.203

Förderstrom/Capacity/Débit/Portata/Kapaciteit/Caudal

Baureihe Pump type Modèle	Tipo Serie Tipo	Nennzahl Nom. speed Vitesse nom.	Velocità di rotazione nom. Nominaal toerental Revoluciones nom.	 KSB KSB Aktiengesellschaft Pumpen Industrie- und Wassertechnik Postfach 13 60, D-91253 Pegnitz Bahnhofplatz 1, D-91257
Etaseco G-I	40-250	2900 1/min		
Angebots-Nr. Project No. No. de l'offre	Offerta-No. Offerten. Oferta-No.	Pos.-Nr. Item No. No. de pos.	Pos.-Nr. Positiennr. Pos.-Nr.	

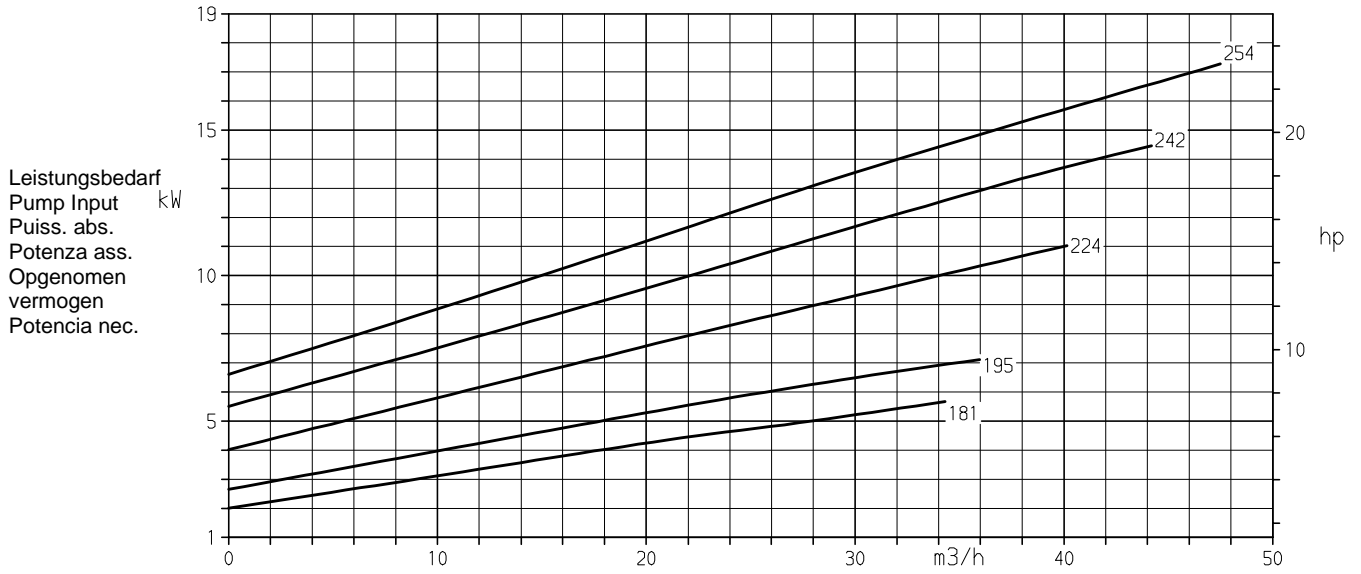
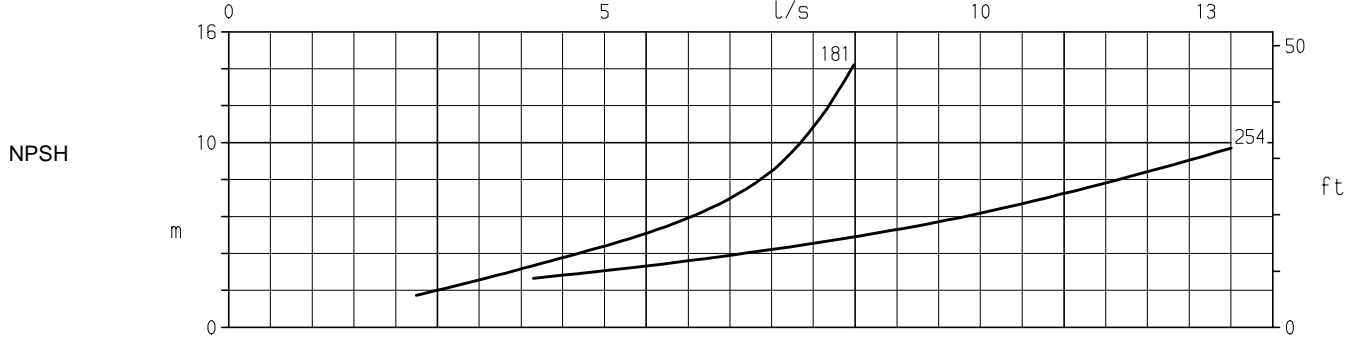
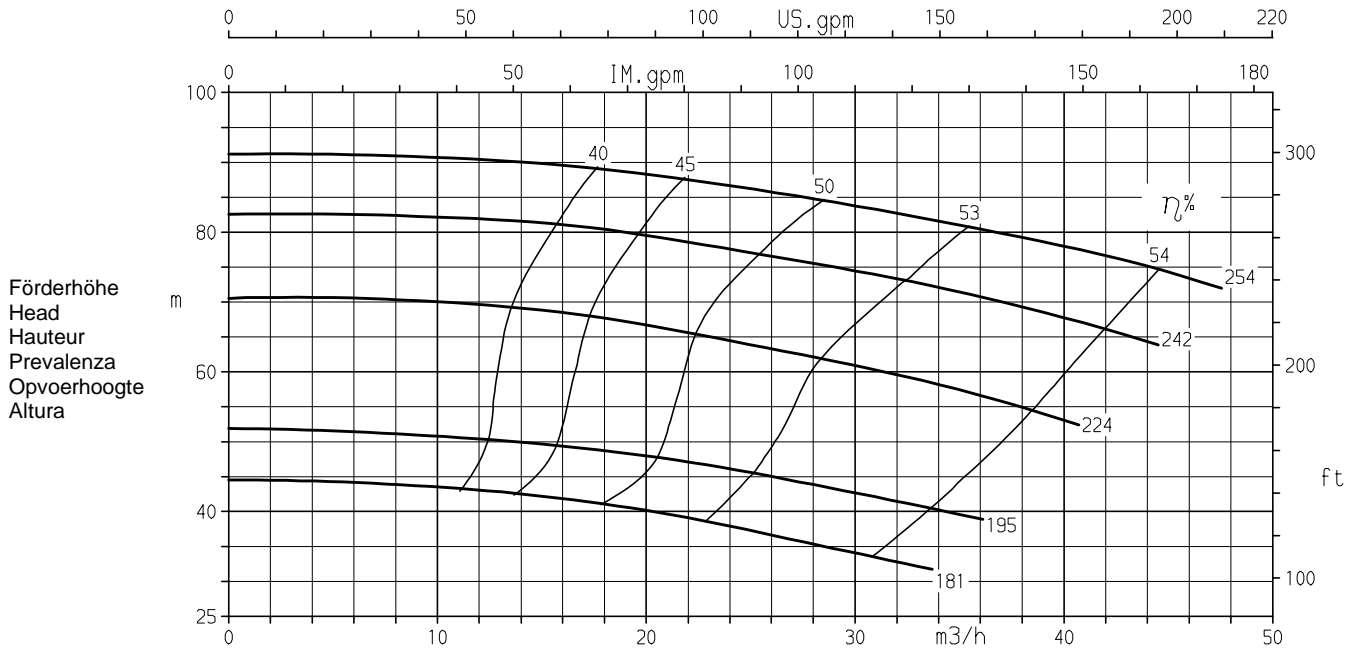

K2935.204

Förderstrom/Capacity/Débit/Portata/Kapaciteit/Caudal

Baureihe Pump type Modèle	Tipo Serie Tipo	Nenndrehzahl Nom. speed Vitesse nom.	Velocità di rotazione nom. Nominaal toerental Revoluciones nom.	 KSB Aktiengesellschaft Pumpen Industrie- und Wassertechnik Postfach 13 60, D-91253 Pegnitz Bahnhofplatz 1, D-91257
Etaseco G-I	50-160	2900 1/min		
Angebots-Nr. Project No. No. de l'offre	Offerta-No. Offertenr. Oferta-No.	Pos.-Nr. Item No. No. de pos.	Pos.-Nr. Positiönr. Pos.-Nr.	

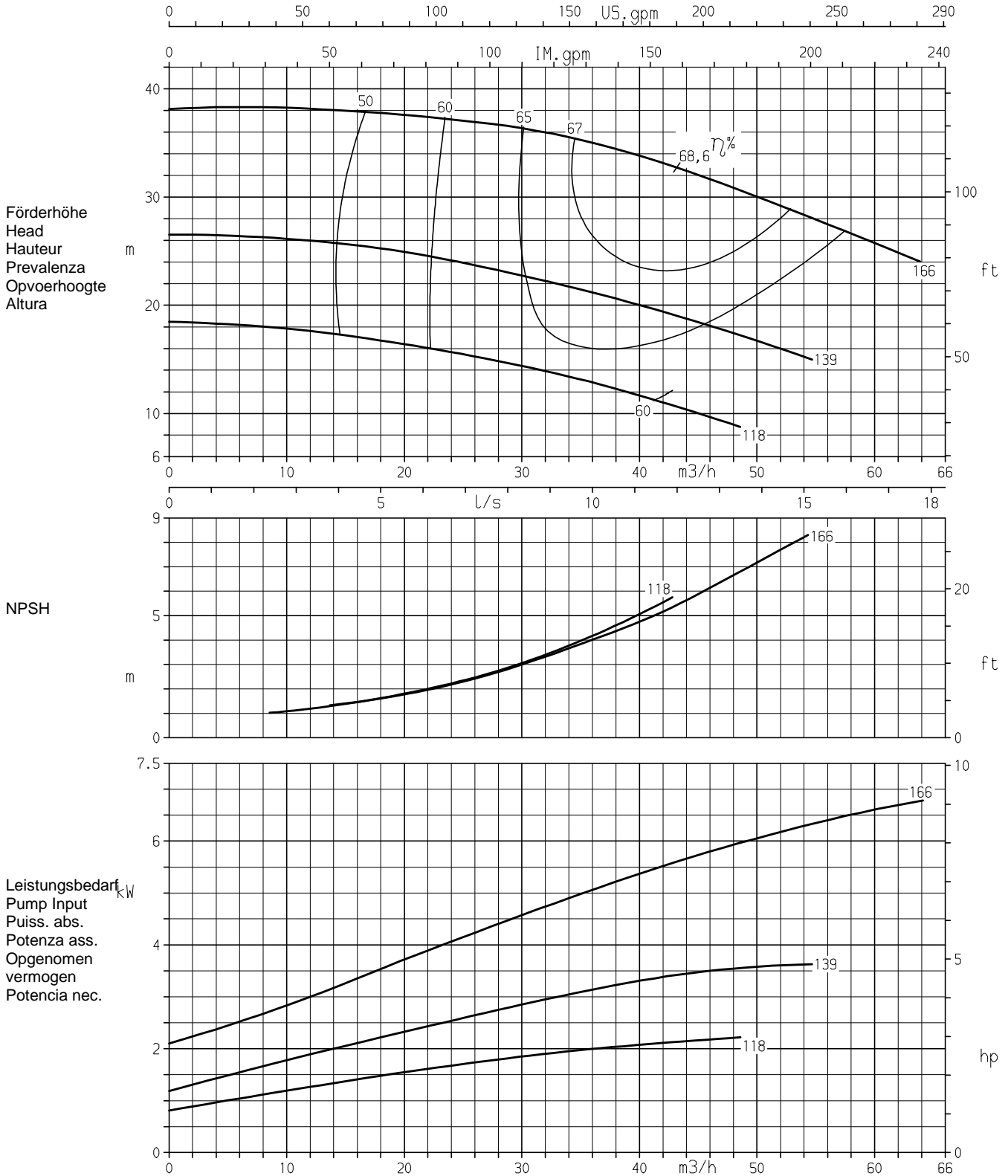

K2935.205

Förderstrom/Capacity/Débit/Portata/Kapaciteit/Caudal

Baureihe Pump type Modèle	Tipo Serie Tipo	Nennndrehzahl Nom. speed Vitesse nom.	Velocità di rotazione nom. Nominaal toerental Revoluciones nom.	 KSB KSB Aktiengesellschaft Pumpen Industrie- und Wassertechnik Postfach 13 60, D-91253 Pegnitz Bahnhofplatz 1, D-91257
Etaseco G-I	50-250	2900 1/min		
Angebots-Nr. Project No. No. de l'offre	Offerta-No. Offerten. Oferta-No.	Pos.-Nr. Item No. No. de pos.	Pos.-Nr. Positiern. Pos.-Nr.	

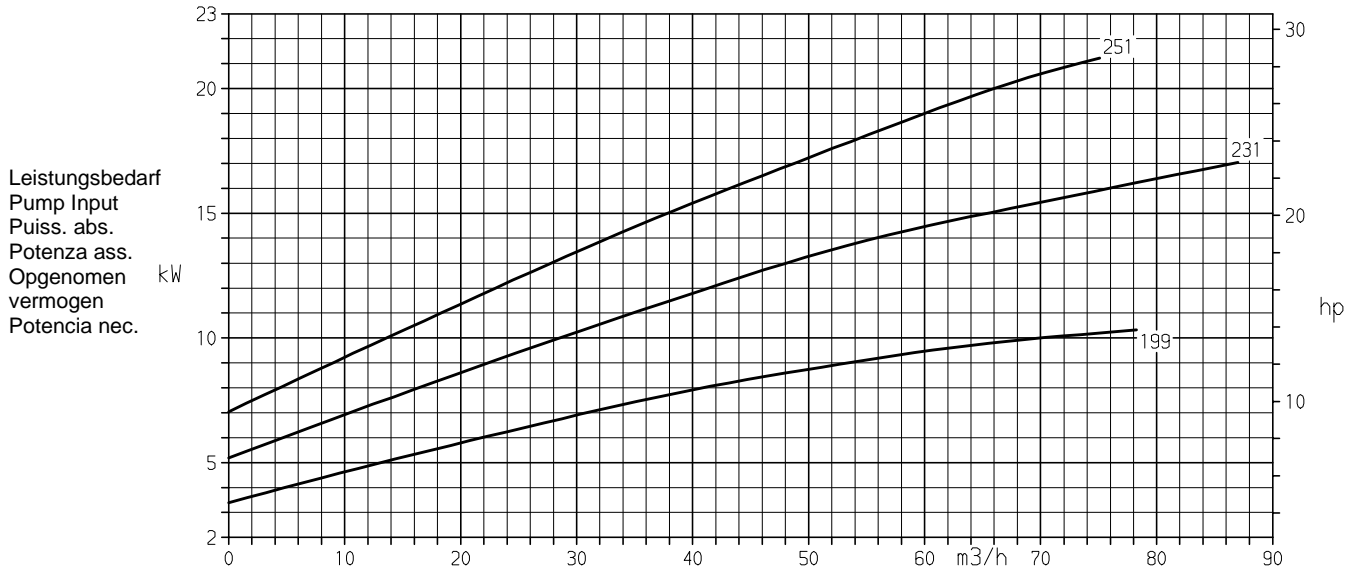
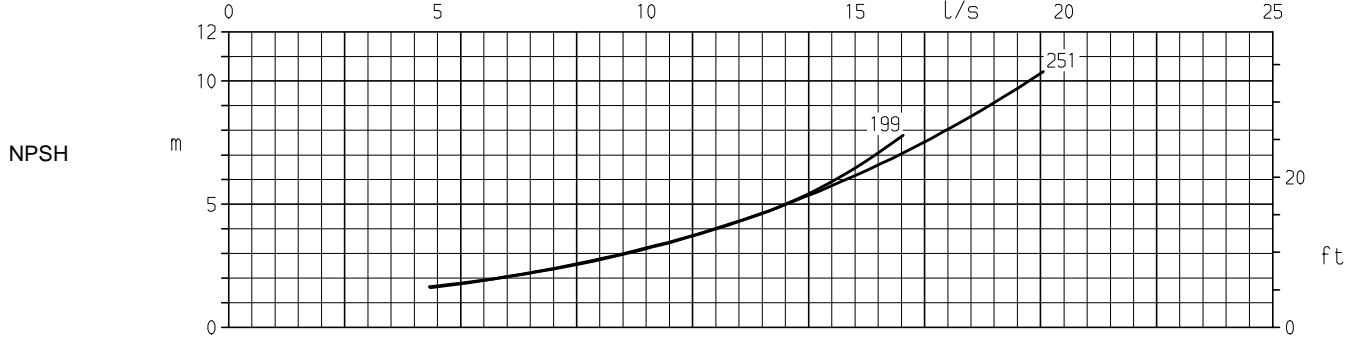
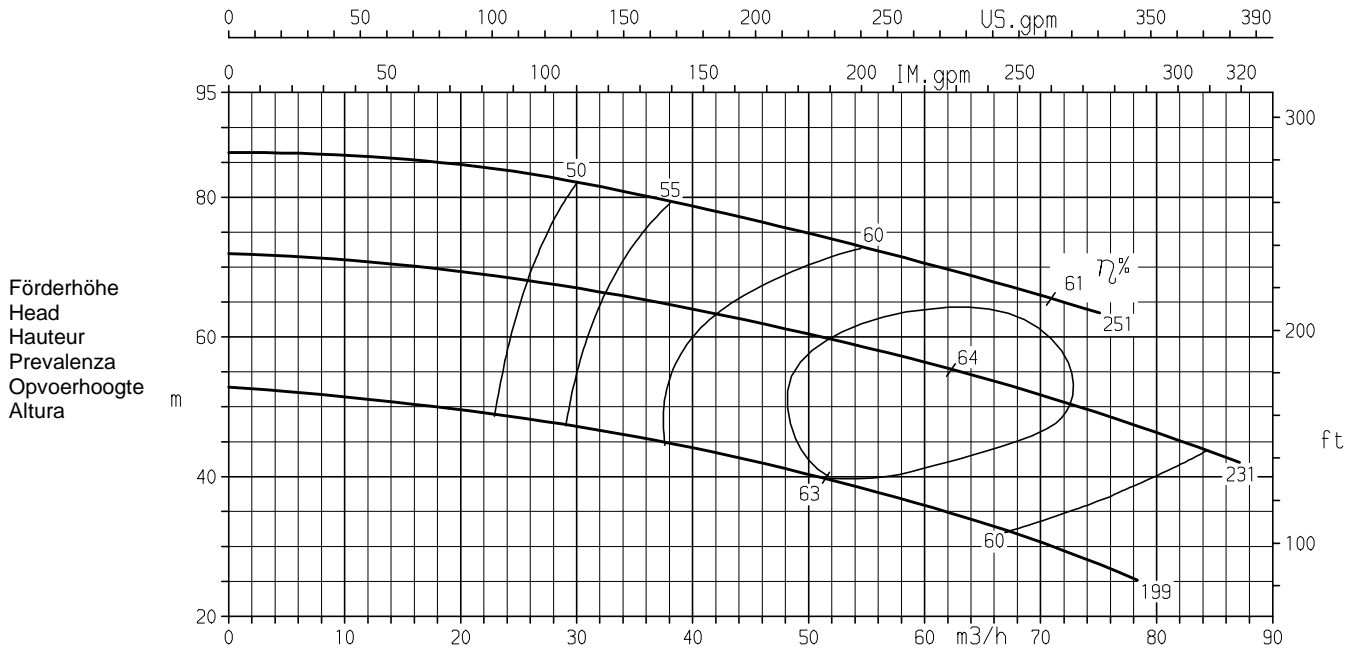

K2935.206

Förderstrom/Capacity/Débit/Portata/Kapaciteit/Caudal

Baureihe Pump type Modèle	Tipo Serie Tipo	Nenndrehzahl Nom. speed Vitesse nom.	Velocità di rotazione nom. Nominaal toerental Revoluciones nom.	 KSB KSB Aktiengesellschaft Pumpen Industrie- und Wassertechnik Postfach 13 60, D-91253 Pegnitz Bahnhofplatz 1, D-91257
Etaseco G-I	65-160	2900 1/min		
Angebots-Nr. Project No. No. de l'offre	Offerta-No. Offertenr. Oferta-No.	Pos.-Nr. Item No. No. de pos.	Pos.-Nr. Positiennr. Pos.-Nr.	

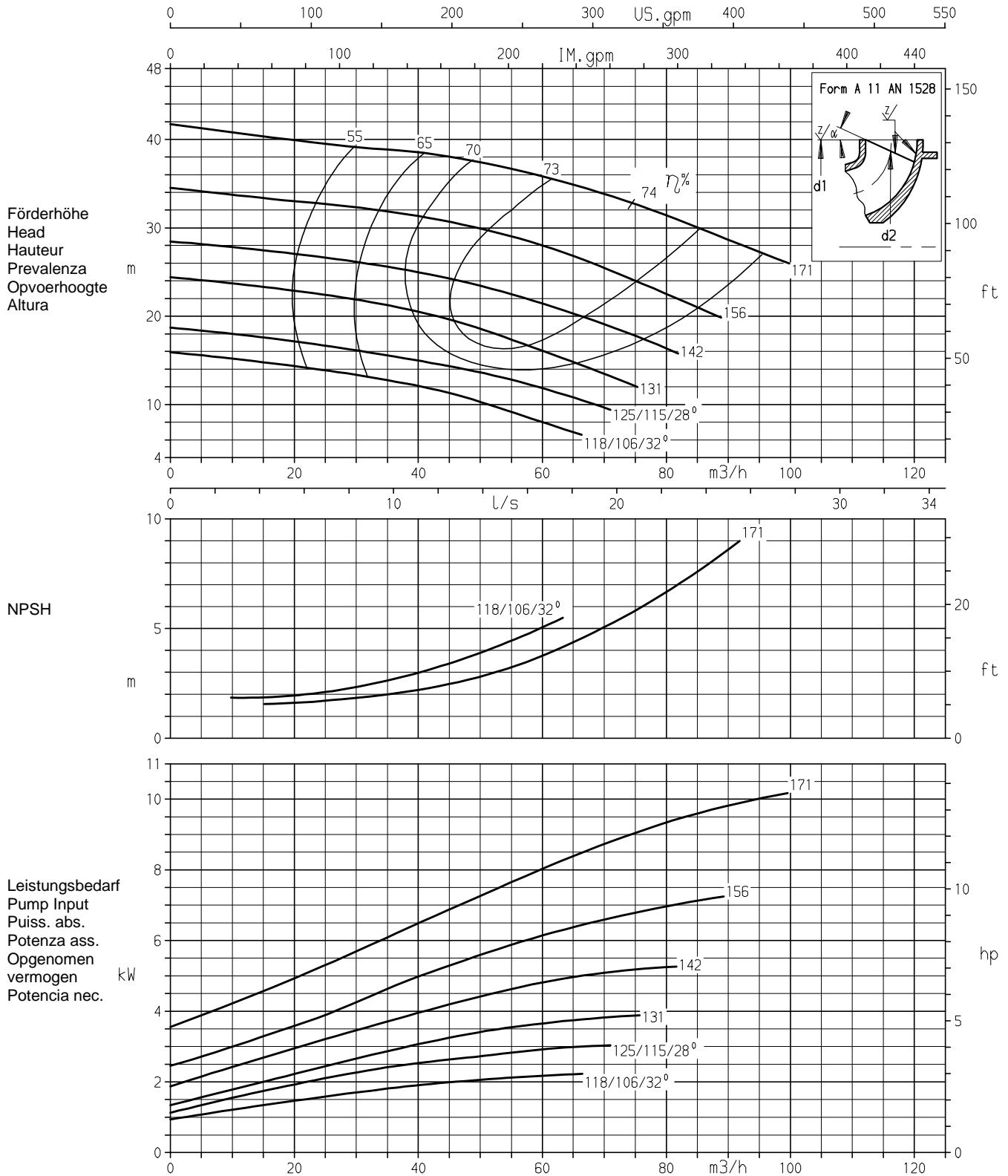

K2935.207/2

Förderstrom/Capacity/Débit/Portata/Kapaciteit/Caudal

Baureihe Pump type Modèle	Tipo Serie Tipo	Nennndrehzahl Nom. speed Vitesse nom.	Velocità di rotazione nom. Nominaal toerental Revoluciones nom.	 KSB KSB Aktiengesellschaft Pumpen Industrie- und Wassertechnik Postfach 13 60, D-91253 Pegnitz Bahnhofplatz 1, D-91257
Etaseco G-I	65-250	2900 1/min		
Angebots-Nr. Project No. No. de l'offre	Offerta-No. Offertenr. Oferta-No.	Pos.-Nr. Item No. No. de pos.	Pos.-Nr. Positiennr. Pos.-Nr.	

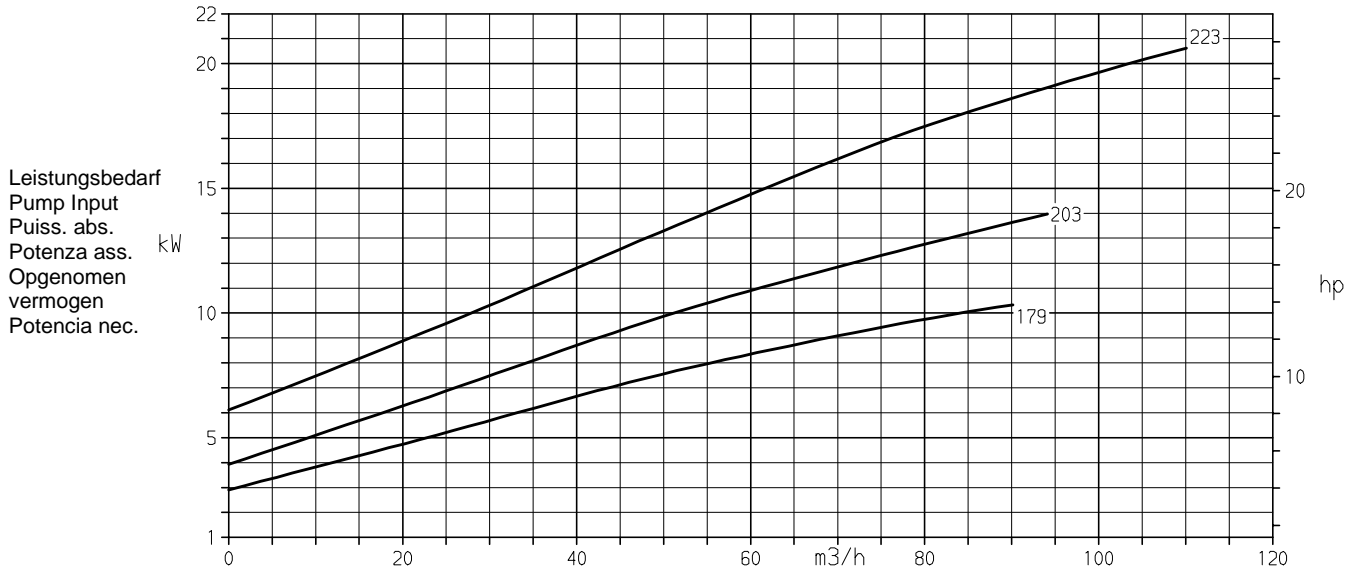
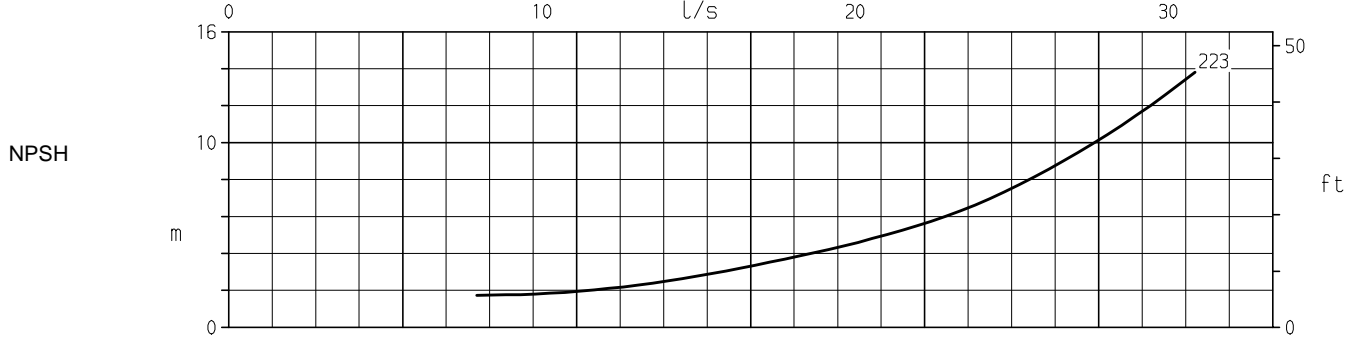
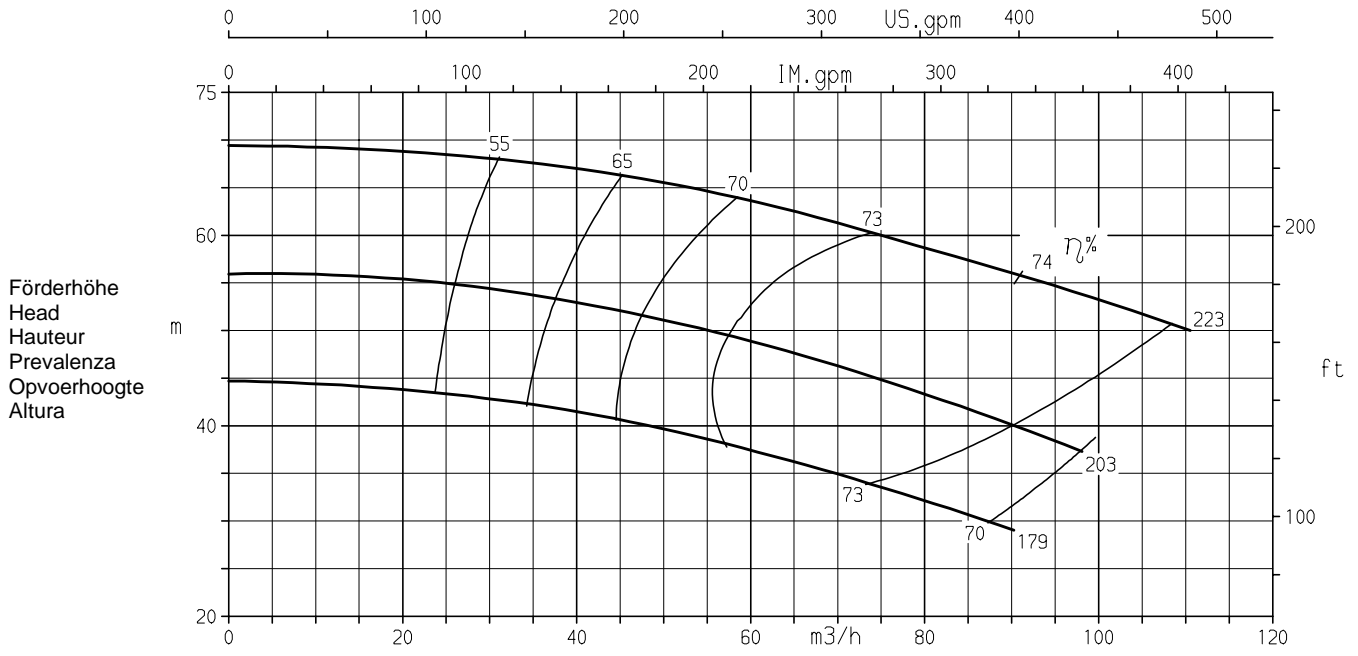

K2935.208

Förderstrom/Capacity/Débit/Portata/Kapaciteit/Caudal

Baureihe Pump type Modèle	Tipo Serie Tipo	Nenndrehzahl Nom. speed Vitesse nom.	Velocità di rotazione nom. Nominaal toerental Revoluciones nom.	 KSB Aktiengesellschaft Pumpen Industrie- und Wassertechnik Postfach 13 60, D-91253 Pegnitz Bahnhofplatz 1, D-91257
Etaseco G-I	80-160	2900 1/min		
Angebots-Nr. Project No. No. de l'offre	Offerta-No. Offertenr. Oferta-No.	Pos.-Nr. Item No. No. de pos.	Pos.-Nr. Positiën. Pos.-Nr.	

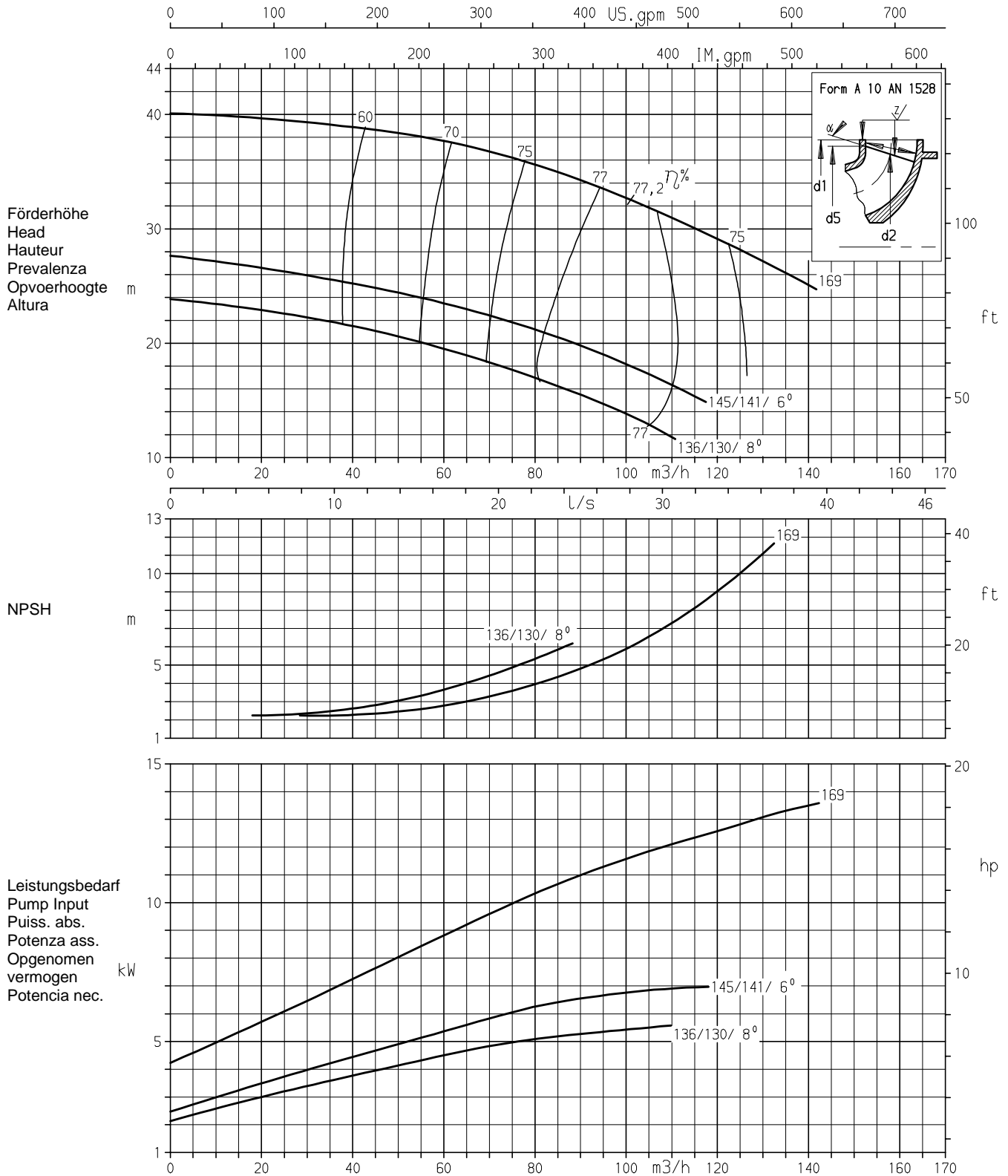

K2935.209/2

Förderstrom/Capacity/Débit/Portata/Kapaciteit/Caudal

Baureihe Pump type Modèle	Tipo Serie Tipo	Nennzahl Nom. speed Vitesse nom.	Velocità di rotazione nom. Nominaal toerental Revoluciones nom.	 KSB KSB Aktiengesellschaft Pumpen Industrie- und Wassertechnik Postfach 13 60, D-91253 Pegnitz Bahnhofplatz 1, D-91257
Etaseco G-I	80-210	2900 1/min		
Angebots-Nr. Project No. No. de l'offre	Offerta-No. Offerten. Oferta-No.	Pos.-Nr. Item No. No. de pos.	Pos.-Nr. Positiern. Pos.-Nr.	

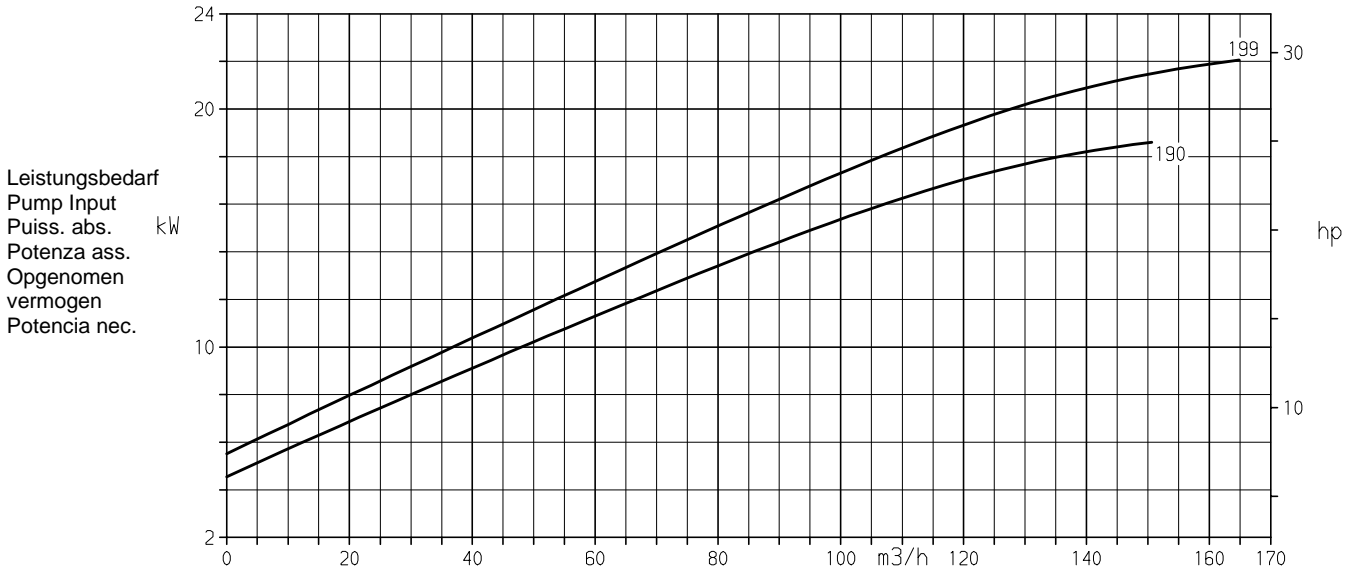
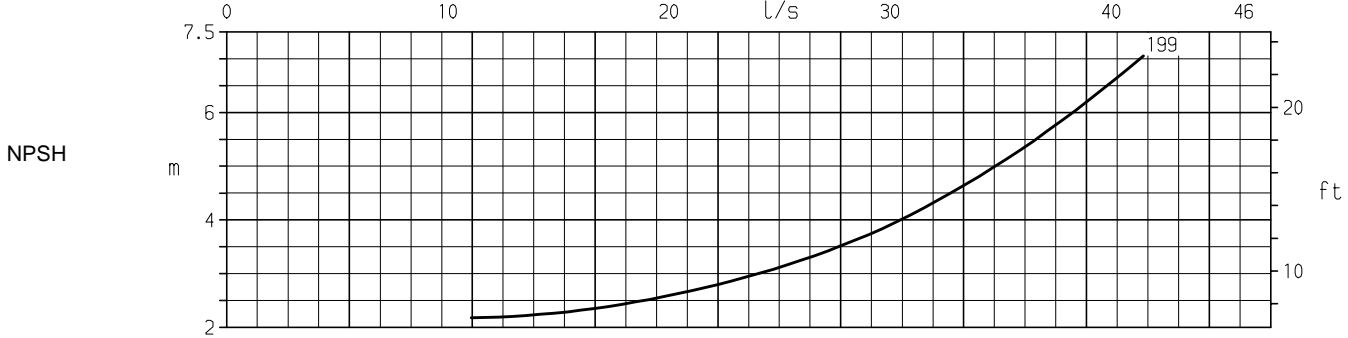
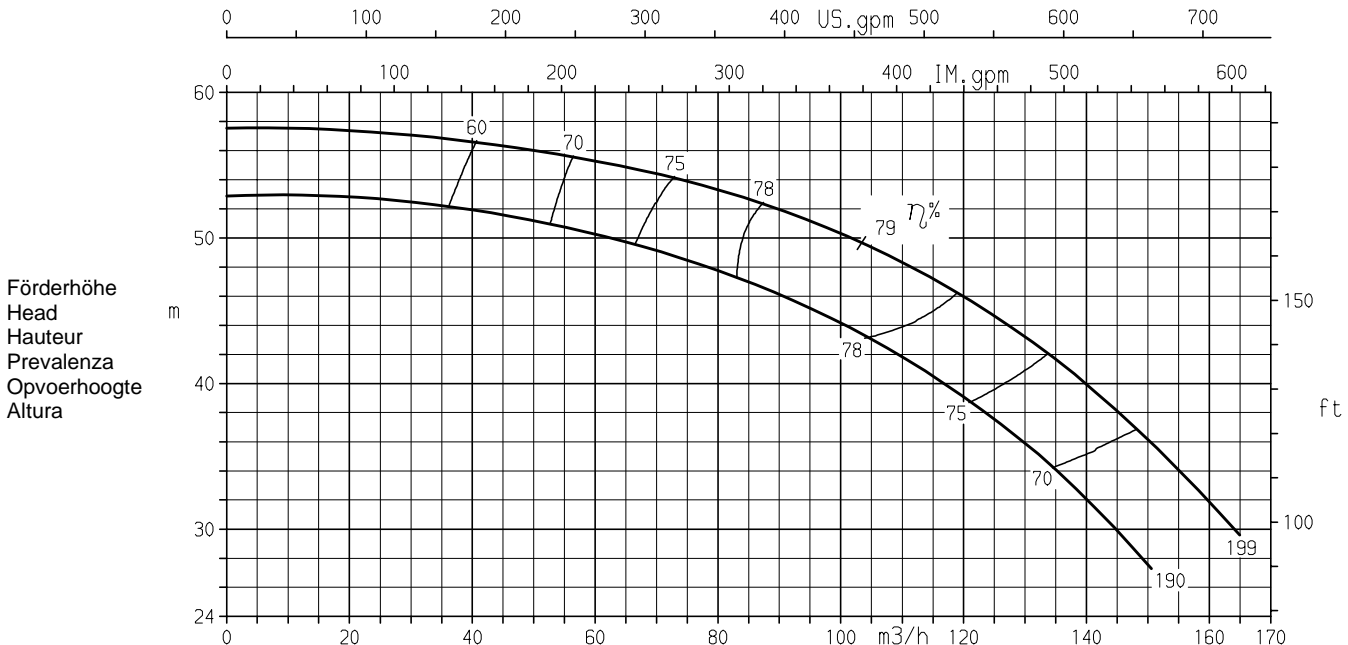

K2935.210

Förderstrom/Capacity/Débit/Portata/Kapaciteit/Caudal

Baureihe Pump type Modèle	Tipo Serie Tipo	Nenndrehzahl Nom. speed Vitesse nom.	Velocità di rotazione nom. Nominaal toerental Revoluciones nom.	 KSB Aktiengesellschaft Pumpen Industrie- und Wassertechnik Postfach 13 60, D-91253 Pegnitz Bahnhofplatz 1, D-91257
Etaseco G-I	100-160	2900 1/min		
Angebots-Nr. Project No. No. de l'offre	Offerta-No. Offertenr. Oferta-No.	Pos.-Nr. Item No. No. de pos.	Pos.-Nr. Positiönr. Pos.-Nr.	

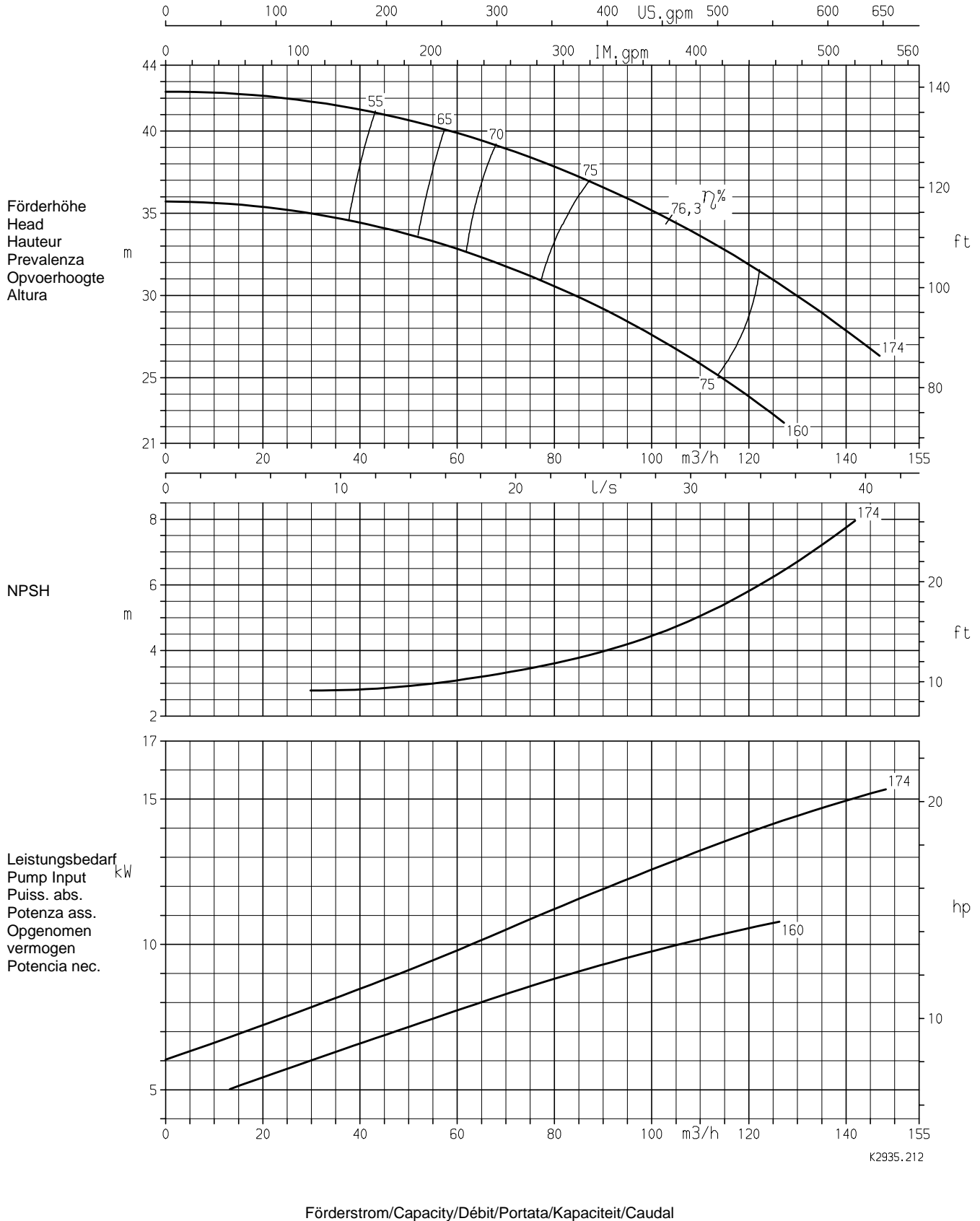

K2935.212

Baureihe Pump type Modèle	Tipo Serie Tipo	Nenn Drehzahl Nom. speed Vitesse nom.	Velocità di rotazione nom. Nominaal toerental Revoluciones nom.	 KSB KSB Aktiengesellschaft Pumpen Industrie- und Wassertechnik Postfach 13 60, D-91253 Pegnitz Bahnhofplatz 1, D-91257
Etaseco S-I	40-160	2900 1/min		
Angebots-Nr. Project No. No. de l'offre	Offerta-No. Offertenr. Oferta-No.	Pos.-Nr. Item No. No. de pos.	Pos.-Nr. Positiönr. Pos.-Nr.	

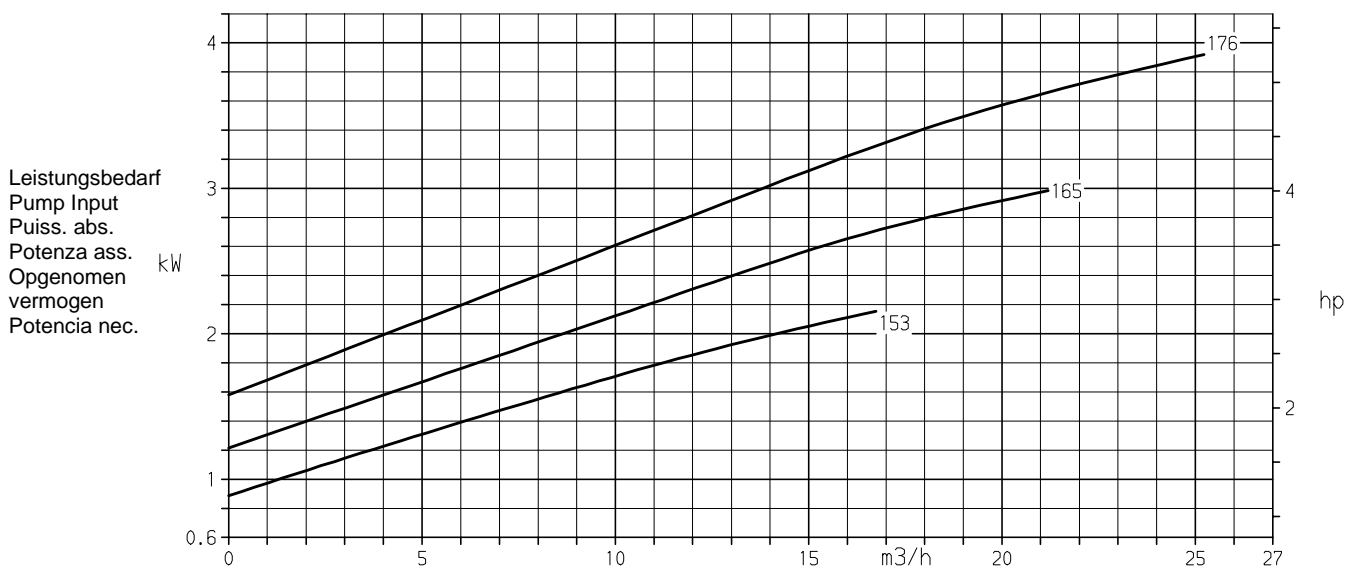
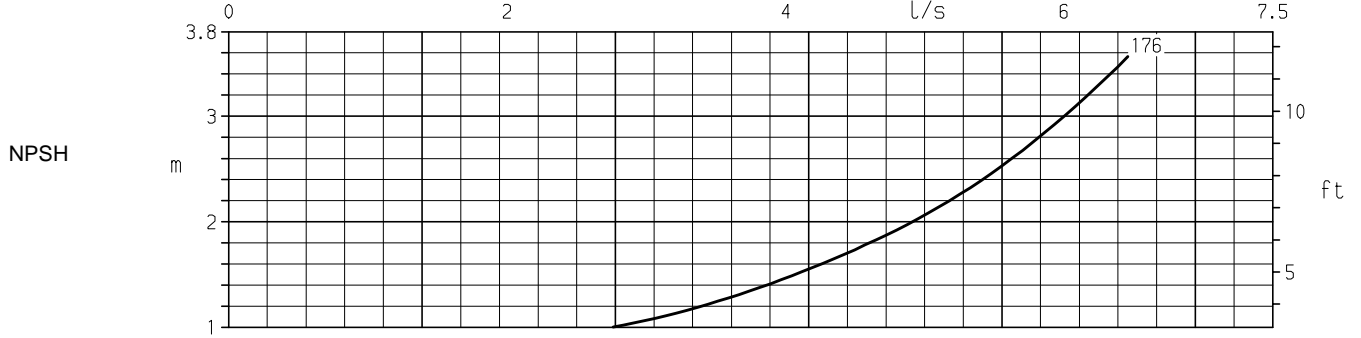
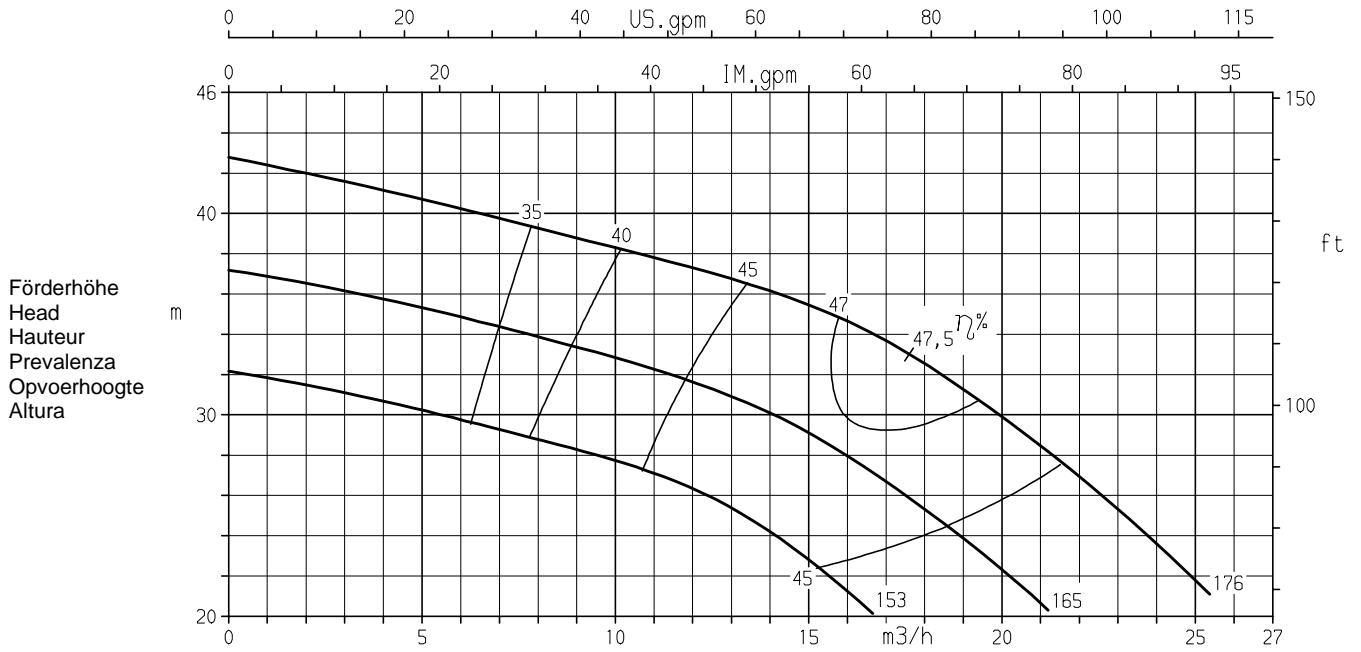

K2935. 301

Förderstrom/Capacity/Débit/Portata/Kapaciteit/Caudal

Baureihe Pump type Modèle	Tipo Serie Tipo	Nenn Drehzahl Nom. speed Vitesse nom.	Velocità di rotazione nom. Nominaal toerental Revoluciones nom.	 KSB Aktiengesellschaft Pumpen Industrie- und Wassertechnik Postfach 13 60, D-91253 Pegnitz Bahnhofplatz 1, D-91257
Etaseco S-I	40-200	2900 1/min		
Angebots-Nr. Project No. No. de l'offre	Offerta-No. Offertenr. Oferta-No.	Pos.-Nr. Item No. No. de pos.	Pos.-Nr. Positiennr. Pos.-Nr.	

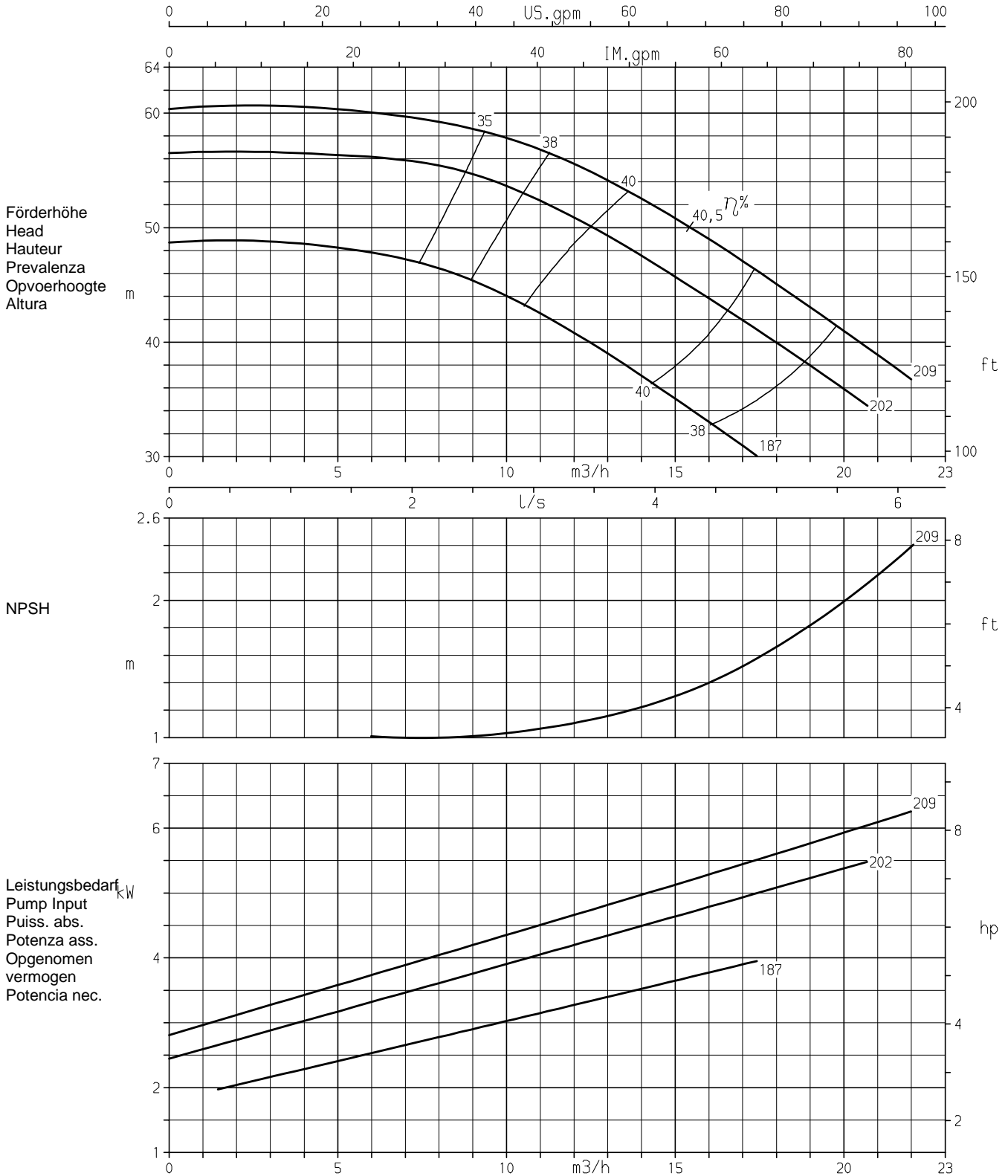

K2935.302

Förderstrom/Capacity/Débit/Portata/Kapaciteit/Caudal

Baureihe Pump type Modèle	Tipo Serie Tipo	Nenndrehzahl Nom. speed Vitesse nom.	Velocità di rotazione nom. Nominaal toerental Revoluciones nom.	 KSB Aktiengesellschaft Pumpen Industrie- und Wassertechnik Postfach 13 60, D-91253 Pegnitz Bahnhofplatz 1, D-91257
Etaseco S-I	50-160	2900 1/min		
Angebots-Nr. Project No. No. de l'offre	Offerta-No. Offertenr. Oferta-No.	Pos.-Nr. Item No. No. de pos.	Pos.-Nr. Positiennr. Pos.-Nr.	

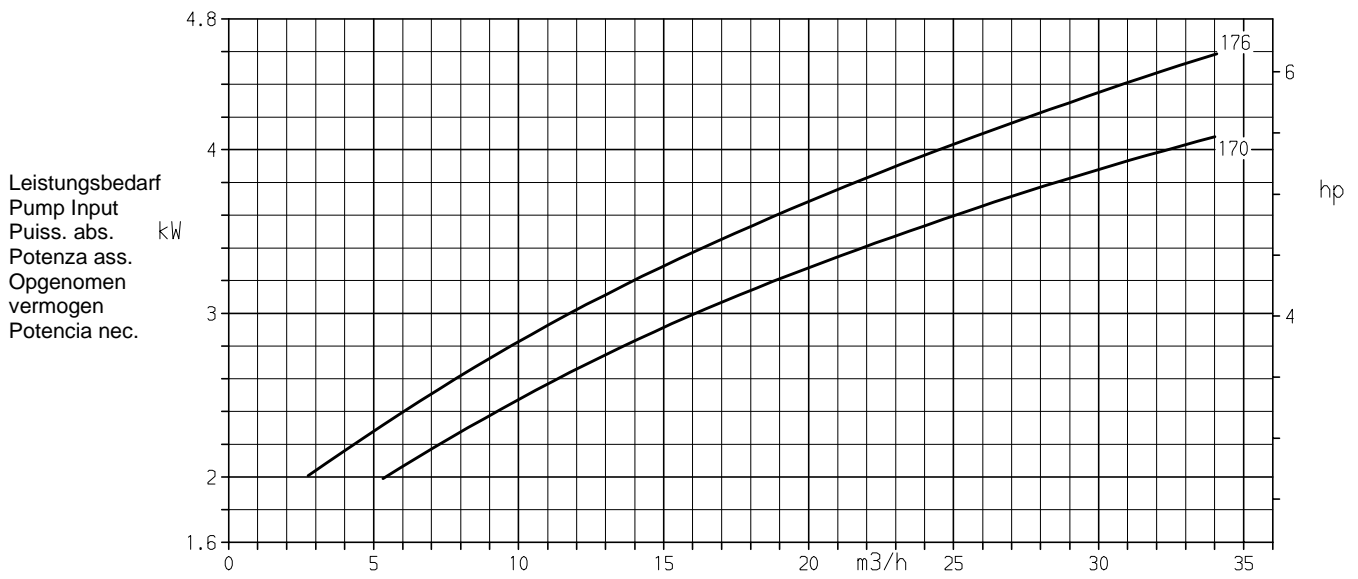
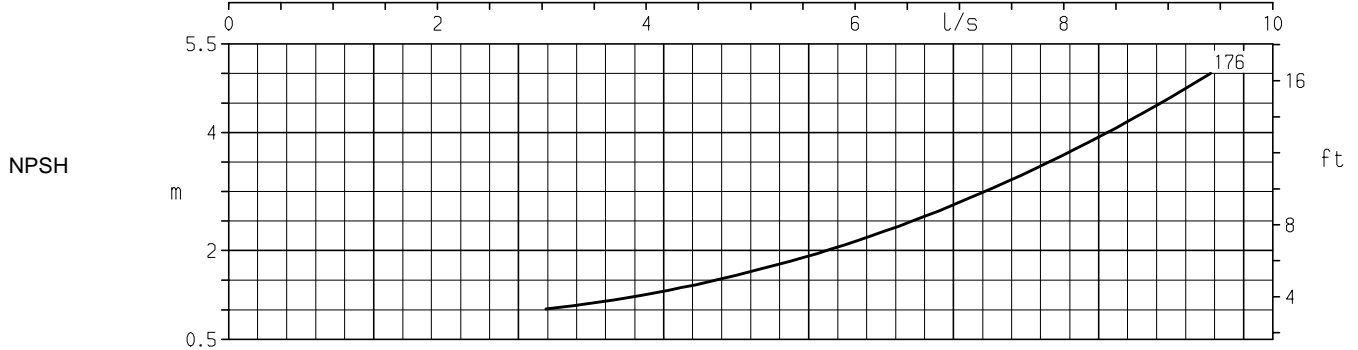
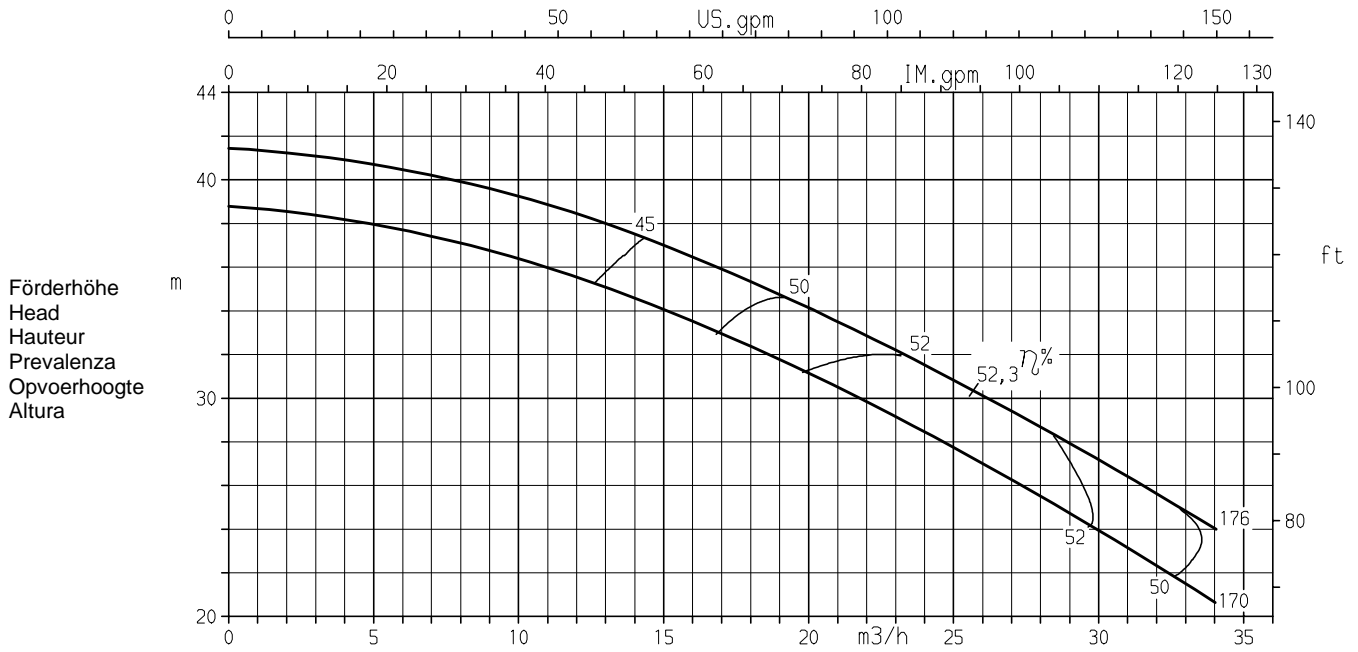

K2935. 303

Förderstrom/Capacity/Débit/Portata/Kapaciteit/Caudal

Baureihe Pump type Modèle	Tipo Serie Tipo	Nenn Drehzahl Nom. speed Vitesse nom.	Velocità di rotazione nom. Nominaal toerental Revoluciones nom.	 KSB KSB Aktiengesellschaft Pumpen Industrie- und Wassertechnik Postfach 13 60, D-91253 Pegnitz Bahnhofplatz 1, D-91257
Etaseco S-I	50-200	2900 1/min		
Angebots-Nr. Project No. No. de l'offre	Offerta-No. Offertenr. Oferta-No.	Pos.-Nr. Item No. No. de pos.	Pos.-Nr. Positiön. Pos.-Nr.	

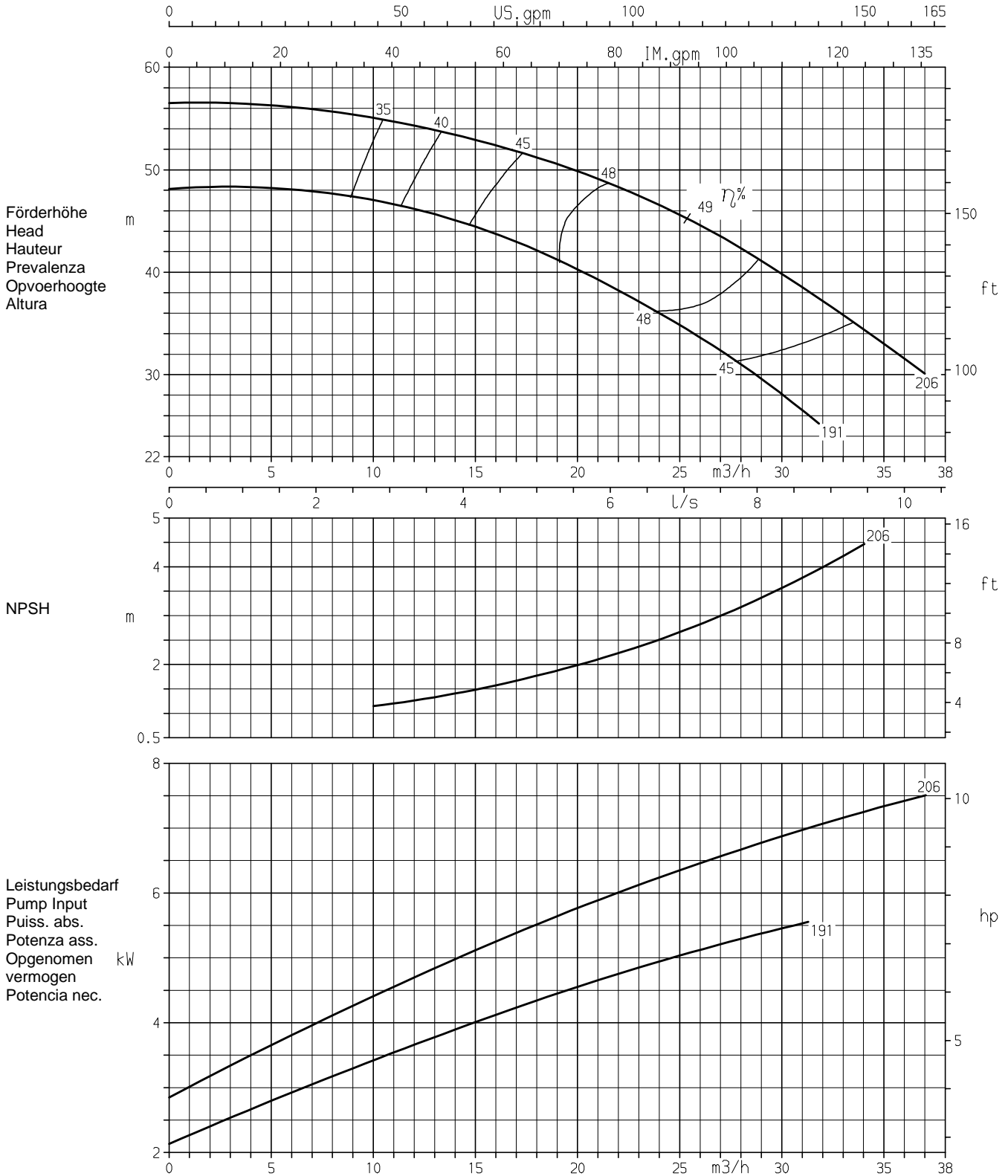

K2935.304

Förderstrom/Capacity/Débit/Portata/Kapaciteit/Caudal

Baureihe Pump type Modèle	Tipo Serie Tipo	Nennzahl Nom. speed Vitesse nom.	Velocità di rotazione nom. Nominaal toerental Revoluciones nom.	 KSB KSB Aktiengesellschaft Pumpen Industrie- und Wassertechnik Postfach 13 60, D-91253 Pegnitz Bahnhofplatz 1, D-91257
Etaseco S-I	65-160	2900 1/min		
Angebots-Nr. Project No. No. de l'offre	Offerta-No. Offertenr. Oferta-No.	Pos.-Nr. Item No. No. de pos.	Pos.-Nr. Positiennr. Pos.-Nr.	

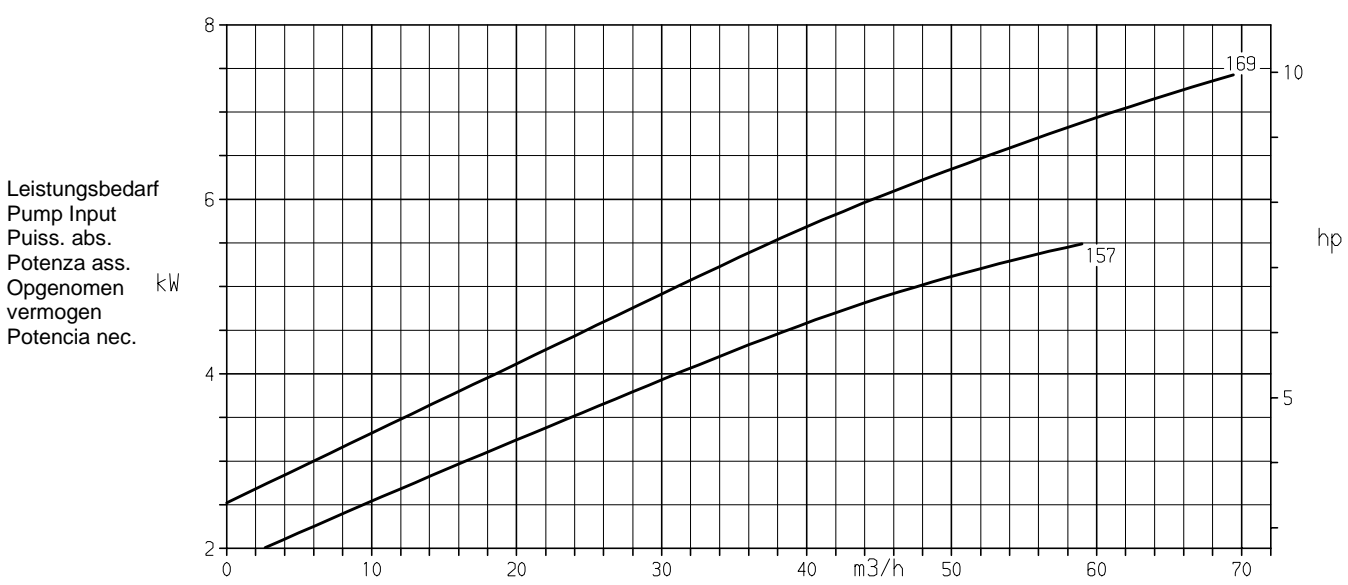
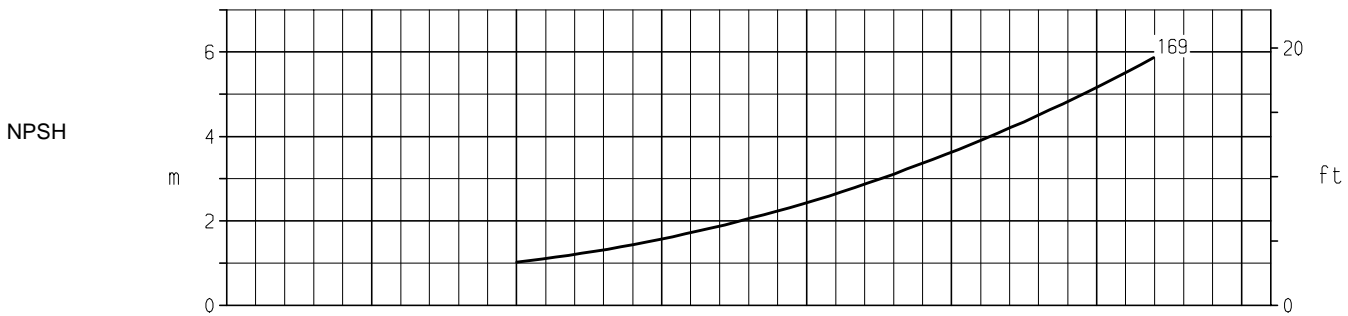
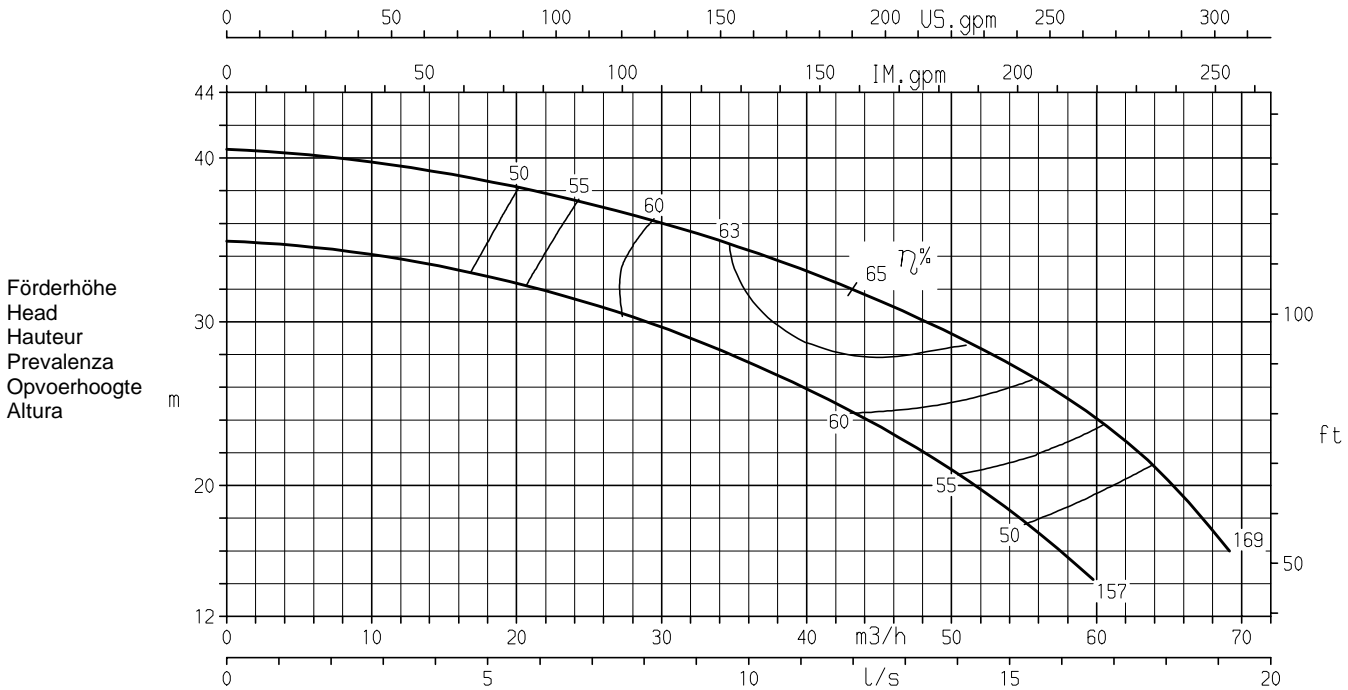

K2935. 305

Förderstrom/Capacity/Débit/Portata/Kapaciteit/Caudal

Baureihe Pump type Modèle	Tipo Serie Tipo	Nenndrehzahl Nom. speed Vitesse nom.	Velocità di rotazione nom. Nominaal toerental Revoluciones nom.	 KSB KSB Aktiengesellschaft Pumpen Industrie- und Wassertechnik Postfach 13 60, D-91253 Pegnitz Bahnhofplatz 1, D-91257
Etaseco S-I	65-200	2900 1/min		
Angebots-Nr. Project No. No. de l'offre	Offerta-No. Offertenr. Oferta-No.	Pos.-Nr. Item No. No. de pos.	Pos.-Nr. Positiën. Pos.-Nr.	

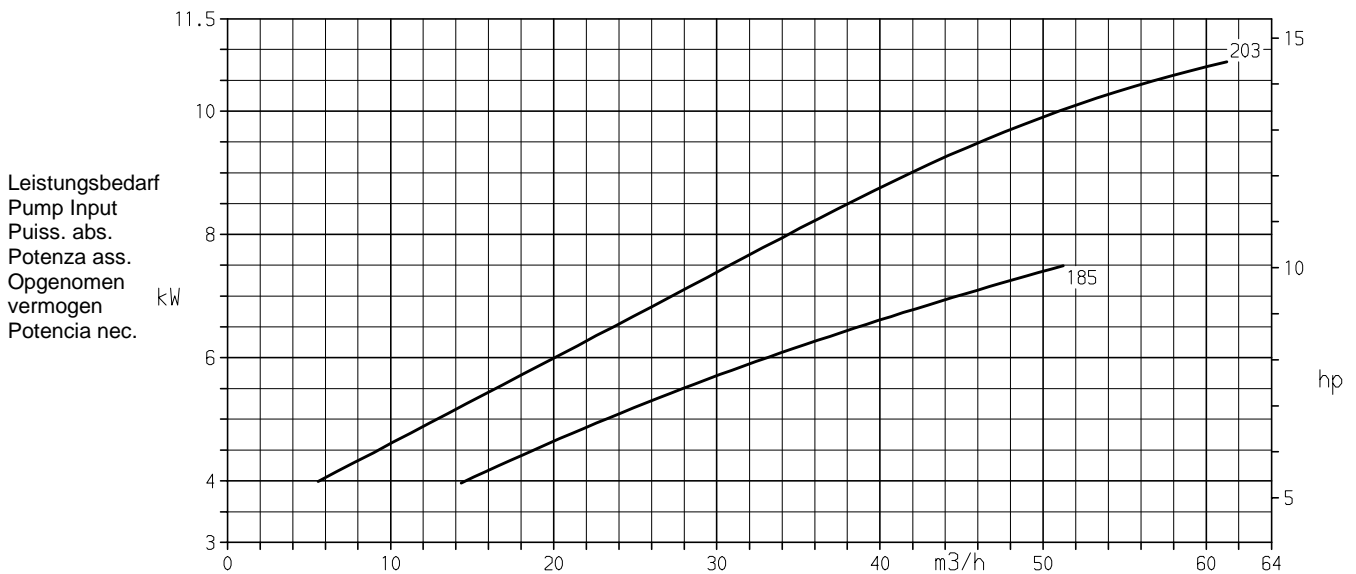
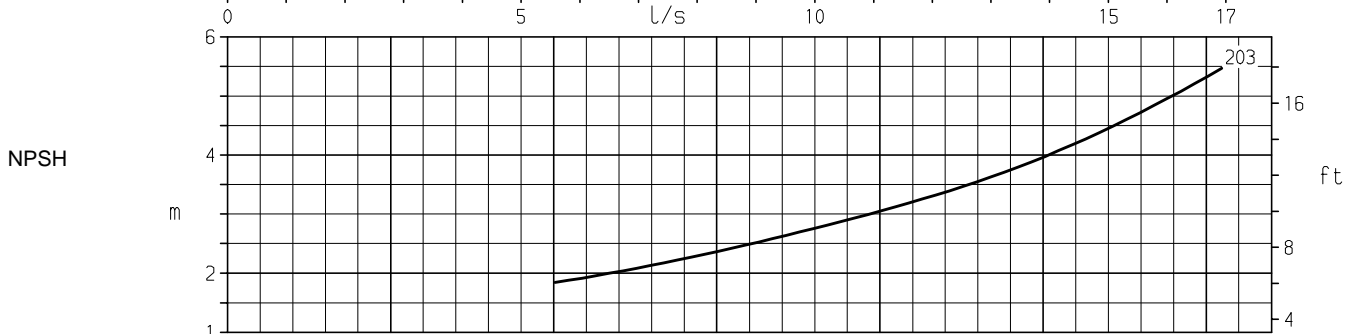
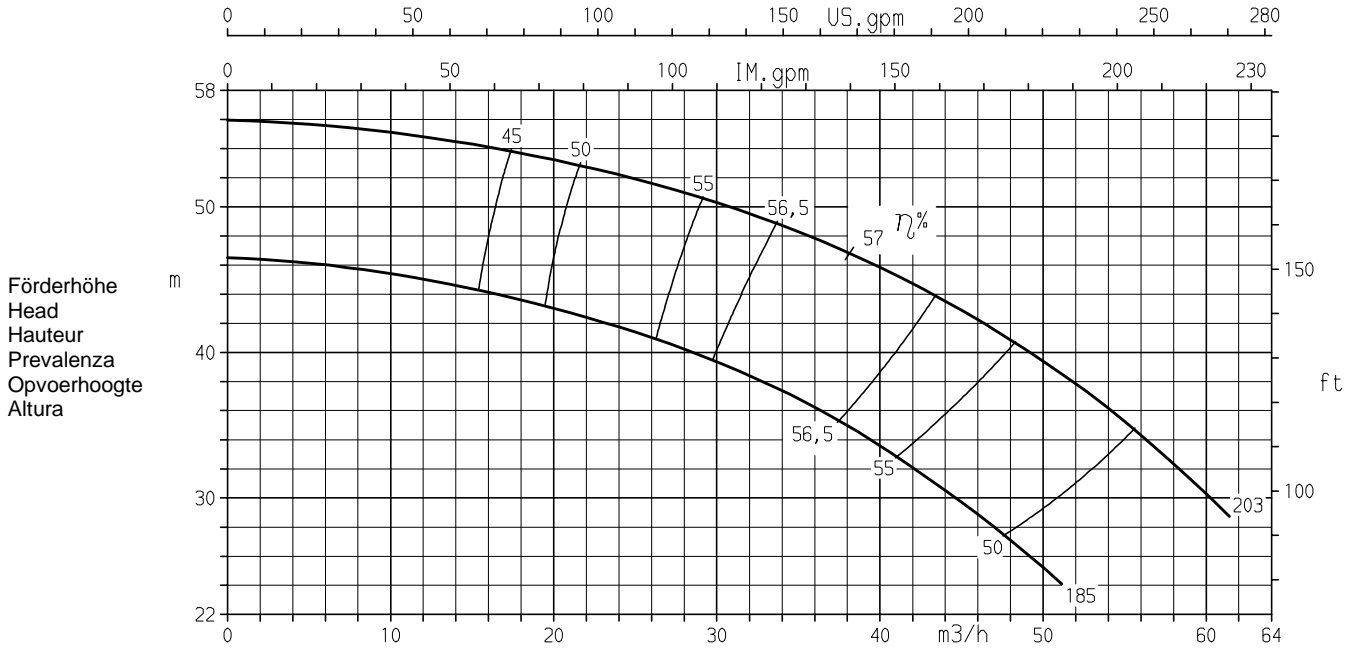

K2935.306

Förderstrom/Capacity/Débit/Portata/Kapaciteit/Caudal

Baureihe Pump type Modèle	Tipo Serie Tipo	Nenn Drehzahl Nom. speed Vitesse nom.	Velocità di rotazione nom. Nominaal toerental Revoluciones nom.	 KSB KSB Aktiengesellschaft Pumpen Industrie- und Wassertechnik Postfach 13 60, D-91253 Pegnitz Bahnhofplatz 1, D-91257
Etaseco S-I	80-160	2900 1/min		
Angebots-Nr. Project No. No. de l'offre	Offerta-No. Offertenr. Oferta-No.	Pos.-Nr. Item No. No. de pos.	Pos.-Nr. Positiönr. Pos.-Nr.	

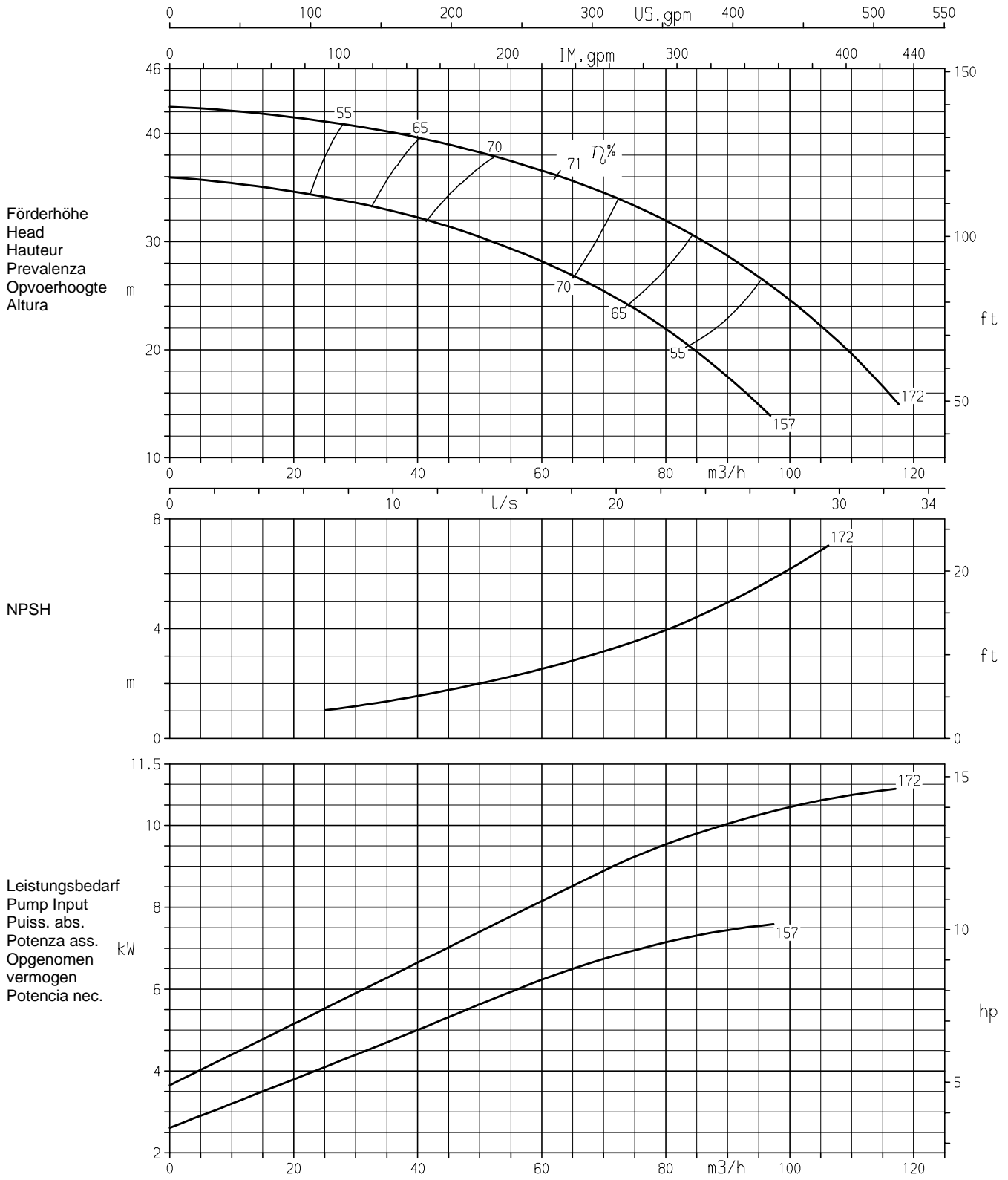

K2935.307

Förderstrom/Capacity/Débit/Portata/Kapazität/Caudal

Baureihe Pump type Modèle	Tipo Serie Tipo	Nenndrehzahl Nom. speed Vitesse nom.	Velocità di rotazione nom. Nominaal toerental Revoluciones nom.	 KSB Aktiengesellschaft Pumpen Industrie- und Wassertechnik Postfach 13 60, D-91253 Pegnitz Bahnhofplatz 1, D-91257
Etaseco S-I	80-200	2900 1/min		
Angebots-Nr. Project No. No. de l'offre	Offerta-No. Offertenr. Oferta-No.	Pos.-Nr. Item No. No. de pos.	Pos.-Nr. Positiën. Pos.-Nr.	

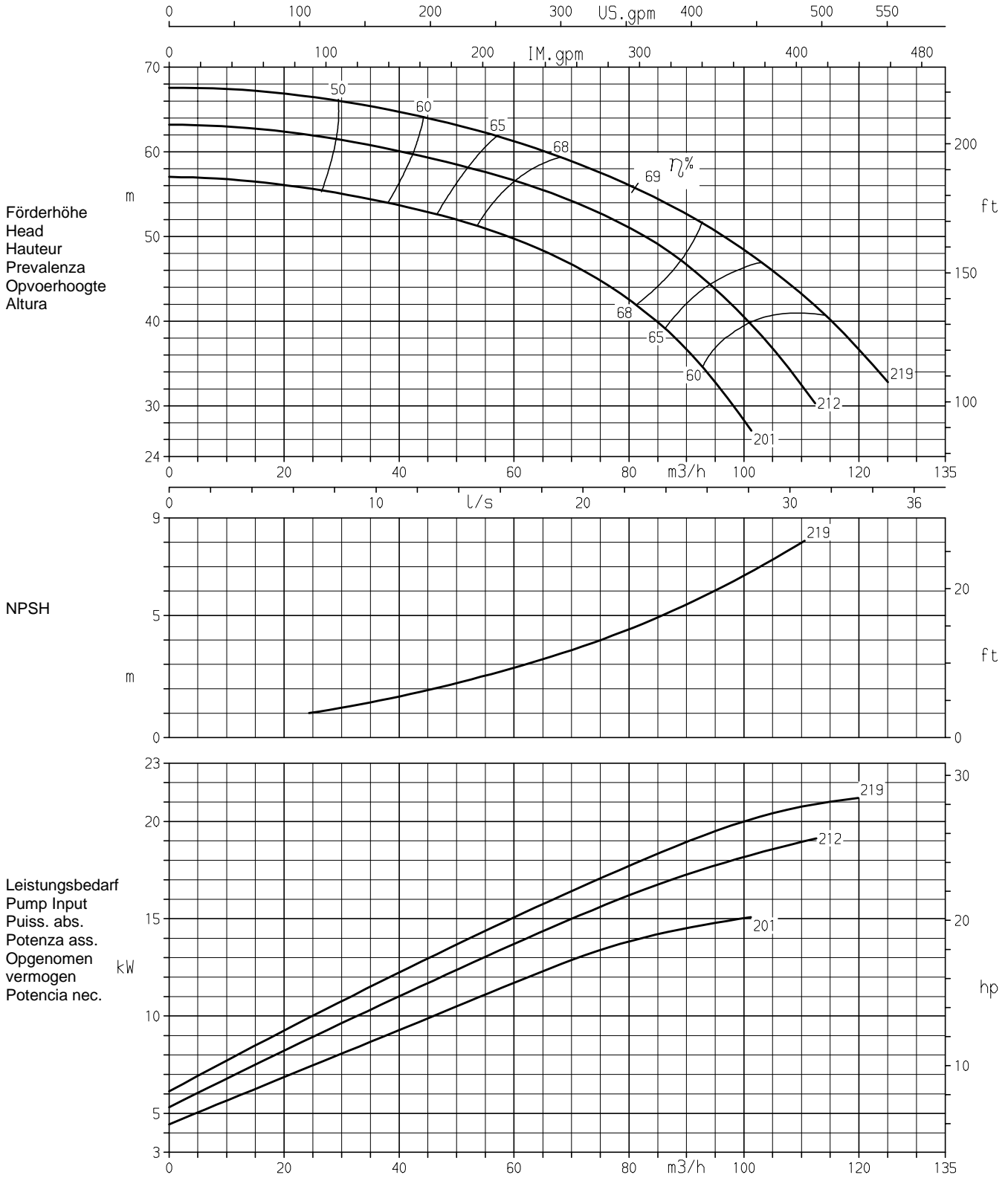

K2935.308

Förderstrom/Capacity/Débit/Portata/Kapaciteit/Caudal

Baureihe Pump type Modèle	Tipo Serie Tipo	Nennndrehzahl Nom. speed Vitesse nom.	Velocità di rotazione nom. Nominaal toerental Revoluciones nom.	 KSB KSB Aktiengesellschaft Pumpen Industrie- und Wassertechnik Postfach 13 60, D-91253 Pegnitz Bahnhofplatz 1, D-91257
Etaseco S-I	100-160	2900 1/min		
Angebots-Nr. Project No. No. de l'offre	Offerta-No. Offertenr. Oferta-No.	Pos.-Nr. Item No. No. de pos.	Pos.-Nr. Positiönr. Pos.-Nr.	

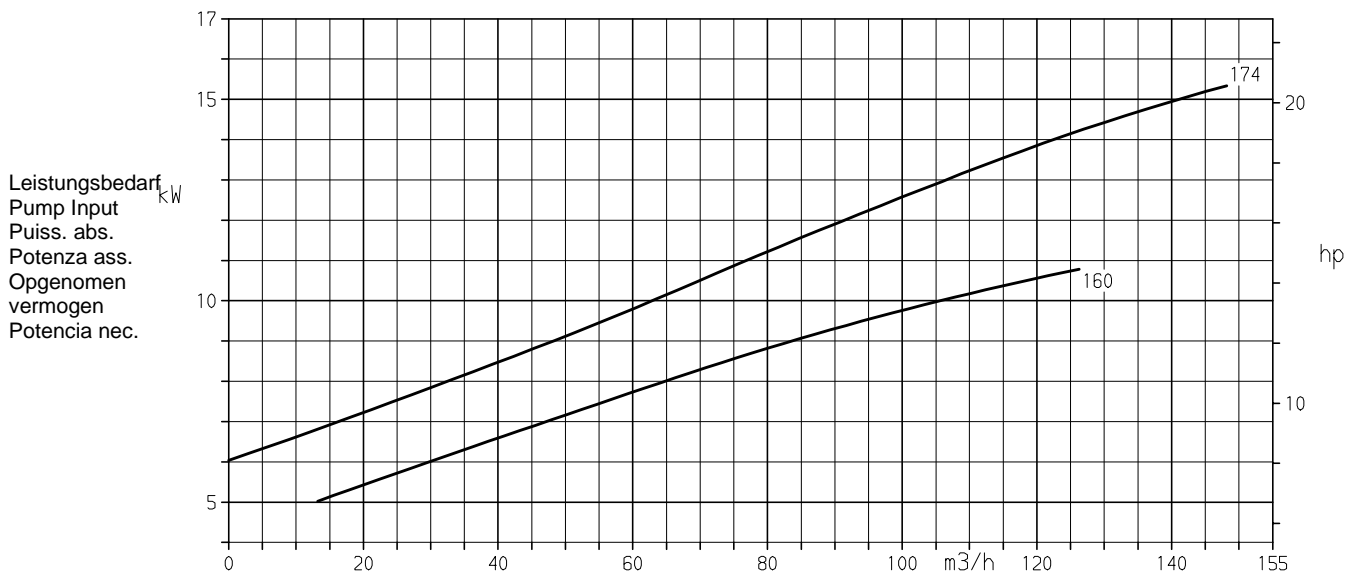
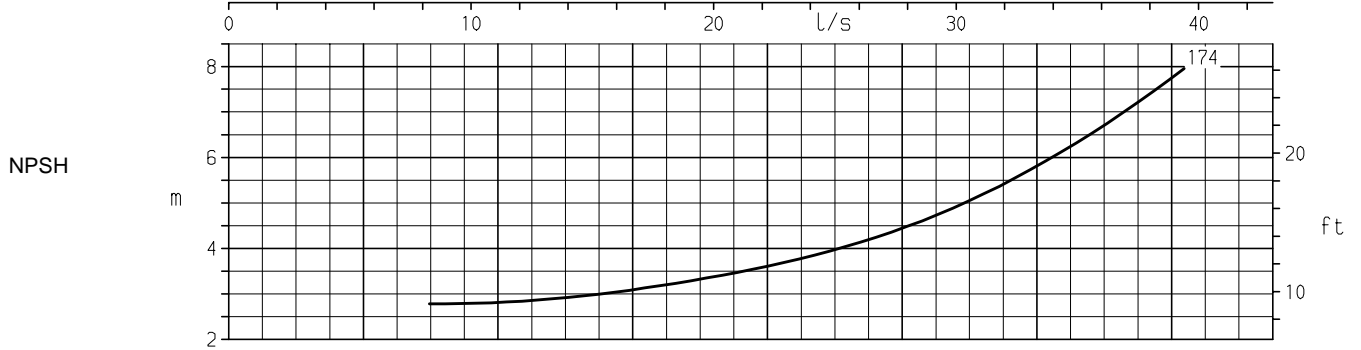
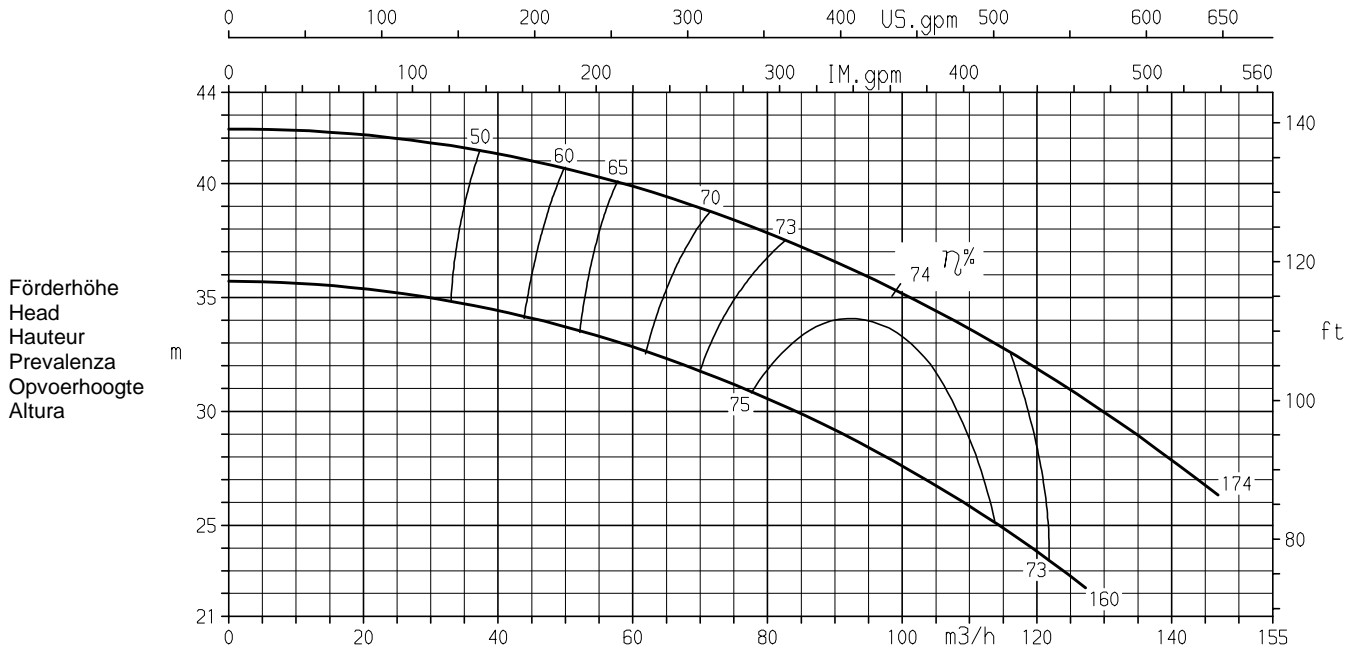

K2935.309

Förderstrom/Capacity/Débit/Portata/Kapaciteit/Caudal

Technische Änderungen bleiben vorbehalten

15.2.2004

2935.54/2-90

